



2K Series

3K Series

4K Series

4K Ready

Smart Security System

INSTRUCTION MANUAL

Important Information

FCC Verification

This equipment has been tested and found to comply with the limits for Class B digital device, pursuant to part 15 of the FCC Rules. These limits are designed to provide reasonable protection against harmful interference in a residential installation. This equipment generates, uses and can radiate radio frequency energy and, if not installed and used in accordance with the instructions, may cause harmful interference to radio or television reception, which can be determined by turning the equipment off and on, the user is encouraged to try to correct the interference by one or more of the following measures:

- Reorient or relocate the receiving antenna
- Increase the separation between the equipment and the receiver
- Connect the equipment into an outlet on a circuit different from that to which the receiver is connected
- Consult the dealer or an experienced radio/TV technician for help

These devices comply with part 15 of the FCC Rules. Operation is subject to the following two conditions:

- These devices may not cause harmful interference
- These devices must accept any interference received, including interference that may cause undesired operation

Important Notice: All jurisdictions have specific laws and regulations relating to the use of cameras. Before using any camera for any purpose, it is the buyer's responsibility to be aware of all applicable laws and regulations that prohibit or limit the use of cameras and to comply with the applicable laws and regulations.

FCC Regulation (for USA): Prohibition against eavesdropping

Except for the operations of law enforcement officers conducted under lawful authority, no person shall use, either directly or indirectly, a device operated pursuant to the provisions of this Part for the purpose of overhearing or recording the private conversations of others unless such use is authorized by all of the parties engaging in the conversation.

Warning: Changes or modifications made to this device not approved expressly by the party responsible for compliance could void the user's authority to operate the equipment.

Important Safety Instructions

- Do not operate if wires and terminals are exposed
- Do not cover vents on the side of your device and allow adequate space for ventilation
- Only use the power adapter supplied with your DVR

About this Instruction Manual

This instruction manual is written for Google Assistant DVR models with the System V8 operating system and was accurate at the time it was completed. However, because of our on-going efforts to constantly improve our products, additional features and functions may have been added since that time.

Important Password Information

This DVR does not have a default password. A password is created during the Startup Wizard. If password protection has been enabled and you have forgotten your password, your DVR's MAC address can be used to create a new password (see page 3 - [Password Recovery](#)).

Password Recovery

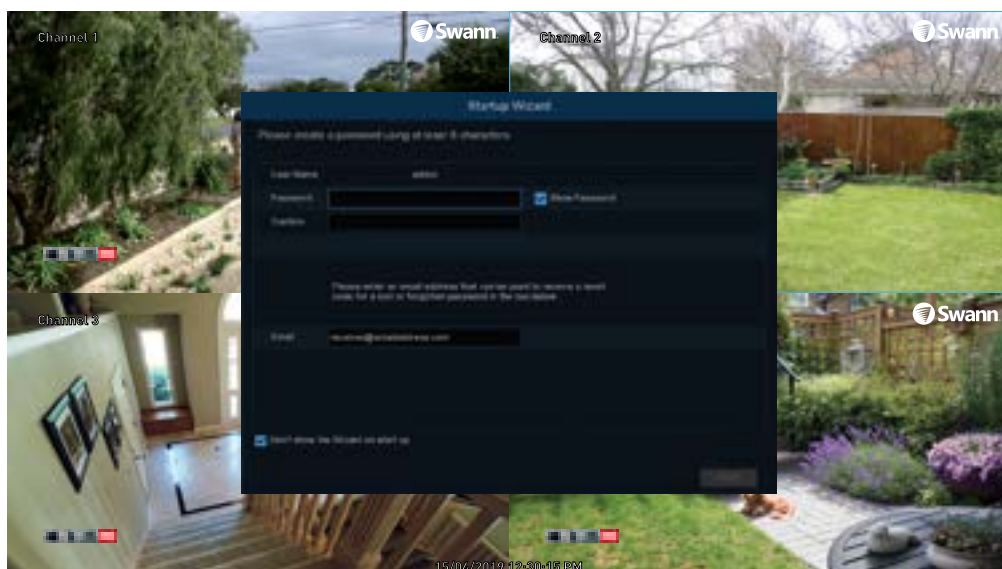
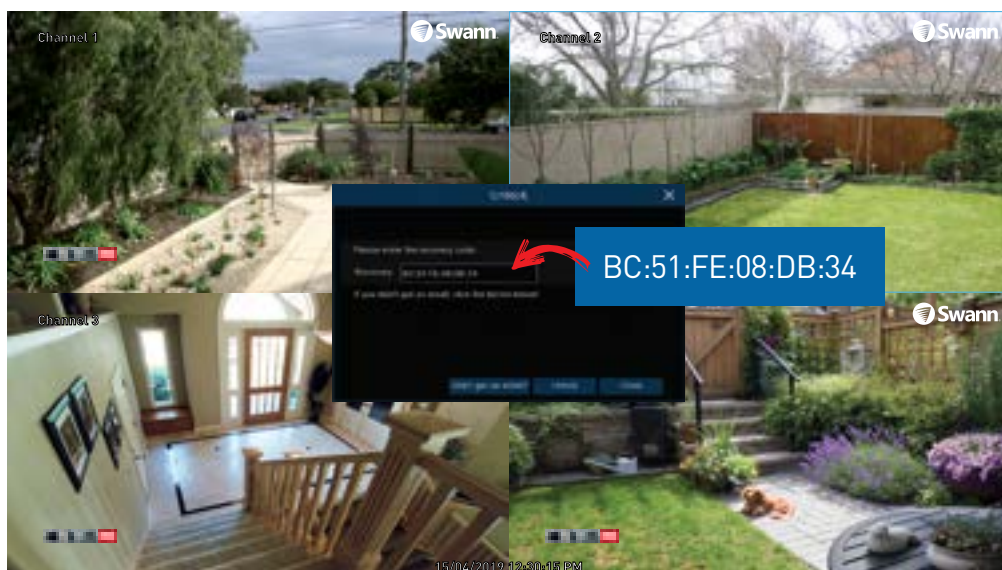

Forgotten your password? Please do the following:

1. Right-click the mouse on the Live View screen to display the Menu Bar, click the "Start" button (bottom left on the Menu Bar) then click "Setup".
2. At the password login screen click "Forgot Password" then click "Yes".
3. After a short moment, you will receive a password reset request email containing your DVR's MAC address (if it's not in your inbox, check your junk or spam folder).
4. Input the MAC address (known as the password recovery code) including the colons (see left example) then click "Unlock".
5. A message will appear on-screen stating that your password has been reset. Click "OK" to continue.
6. Enter a new password. The password has to be a minimum of six characters and can contain a mixture of numbers and letters. Use a password that you are familiar with, but is not easily known to others.
7. Write down your password in the space provided below for safe keeping.
8. Click "Finish" to continue. A message will appear on-screen. Click "OK" to close.

Don't forget to write down your password: _____

I have disabled email notifications, what can I do? Don't worry, you can use HomeSafe View to retrieve your recovery code, so you can reset your DVR's password (see page 138 - [Password Recovery using HomeSafe View](#)).

Contents

Important Information	2	Spotlight Detection Setup	35
Password Recovery	3	Spotlight Trigger Schedule	36
Live View	7	Device: PTZ	37
Live View Mode	8	Controlling your PTZ Camera	38
Live View Controls	9	Creating a Preset	39
Live View Icons	10	OSD: 4K Series - Main Menu	41
Live View Digital Zoom Mode	11	OSD: 4K Series - Exposure	42
Main Menu	12	OSD: 4K Series - Exposure: BLC	43
Menu Layout	13	OSD: 4K Series - Exposure: BLC - Area	44
Camera Configuration	14	OSD: 4K Series - White Bal (Balance)	45
Display: Live	15	OSD: 4K Series - Day & Night: Ext	46
Display: Privacy Zone	17	OSD: 4K Series - Day & Night: Auto	47
Enabling a Privacy Mask	18	OSD: 4K Series - Day & Night: Color	48
Record: Mainstream (4K Series & 4K Ready)	19	OSD: 4K Series - Day & Night: B/W (Black & White)	49
Record: Mainstream (3K Series)	21	OSD: 4K Series - Adjust	50
Record: Mainstream (2K Series)	23	OSD: 4K Series - Adjust: NR (Noise Reduction)	52
Record: Substream	25	OSD: 4K Series - Adjust: Color Gain	53
Alarm: Detection (4K, 3K & 2K Series)	27	OSD: 4K Series - Hidden	54
Alarm: Detection (4K Ready)	28	OSD: 3K Series - Main Menu	55
Alarm: Detection - Actions (4K, 3K & 2K Series)	29	OSD: 3K Series - AE (Auto Exposure)	56
Alarm: Detection - Actions (4K Ready)	30	OSD: 3K Series - AWB (Automatic White Balance)	57
Motion Detection Setup	31	OSD: 3K Series - Day-Night	58
Motion Detection Tips	32	OSD: 3K Series - Image Enhance	59
Thermal-Sensing Camera Tips	33	OSD: 4K Ready - Main Menu	60
Alarm: Deterrent (Spotlight Compatible Cameras)	34	OSD: 4K Ready - AE (Auto Exposure)	61

Contents

OSD: 4K Ready - AWB (Automatic White Balance)	62	Analytics: SOD (Stationary Object Detection) - Actions	87
OSD: 4K Ready - Day/Night	63	Drawing an Object Detection Region	88
OSD: 4K Ready - Image Enhance	64	Analytics: Schedule	89
OSD: 2K Series - Main Menu	65	Recording Configuration	90
OSD: 2K Series - Exposure	66	Record: Record	91
OSD: 2K Series - Backlight: BLC	67	Record: Schedule	92
OSD: 2K Series - Backlight: BLC - Area	68	Capture: Capture	93
OSD: 2K Series - White Bal (Balance)	69	Capture: Schedule	94
OSD: 2K Series - Day&Night: Ext	70	Event Playback & Backup	95
OSD: 2K Series - Day&Night: Auto	71	Search: General	96
OSD: 2K Series - Day&Night: Color	72	Search: Events (copy events to a USB flash drive)	99
OSD: 2K Series - Day&Night: B/W	73	Search: QuickShot (copy snapshots to a USB flash drive)	101
OSD: 2K Series - NR (Noise Reduction)	74	Playing a Slideshow	102
OSD: 2K Series - Special	75	Search: QuickReview	103
OSD: 2K Series - Adjust	76	Search: Smart	104
OSD: 2K Series - Adjust: Monitor	77	Search: Tag	106
OSD: 2K Series - Adjust: Output Mode	78	Search: External File	107
Analytics	79	System Configuration	108
Analytics: PID (Perimeter Intrusion Detection)	80	Display: Display Configuration	109
Analytics: PID (Perimeter Intrusion Detection) - Actions	81	Network: Network	110
Drawing a Perimeter Intrusion Region	82	Network: Wi-Fi	111
Analytics: LCD (Line Crossing Detection)	83	Network: Port Configuration & RTSP	112
Analytics: LCD (Line Crossing Detection) - Actions	84	Using RTSP	113
Drawing a Detection Line	85	Network: Email Configuration	114
Analytics: SOD (Stationary Object Detection)	86	Network: Email Schedule	115

Contents

Network: DDNS	116
Network: IP Filter	117
Device: HDD	118
Device: S.M.A.R.T	119
Device: Cloud Storage	120
System: General	121
System: Date and Time	122
System: Users	123
Advanced: Maintain	124
Advanced: Events	125
Advanced: Auto Upgrade	126
Advanced: Remote Support	127
System Status	128
System: Information	129
System: Channel Information & Record Info	130
System: Network State	131
Search: Log	132
Glossary	133
Password Recovery using HomeSafe View	138
Installing an Internal Hard Drive	140
Frequently Asked Questions	141
Warranty Information	142
Help & Resources	143

Live View

Live View is the default display mode for your DVR. Each camera connected will be displayed on-screen. You can check the status or operation of your DVR and cameras using the icons and Menu Bar on the Live View screen. Right-click the mouse to access the Menu Bar.

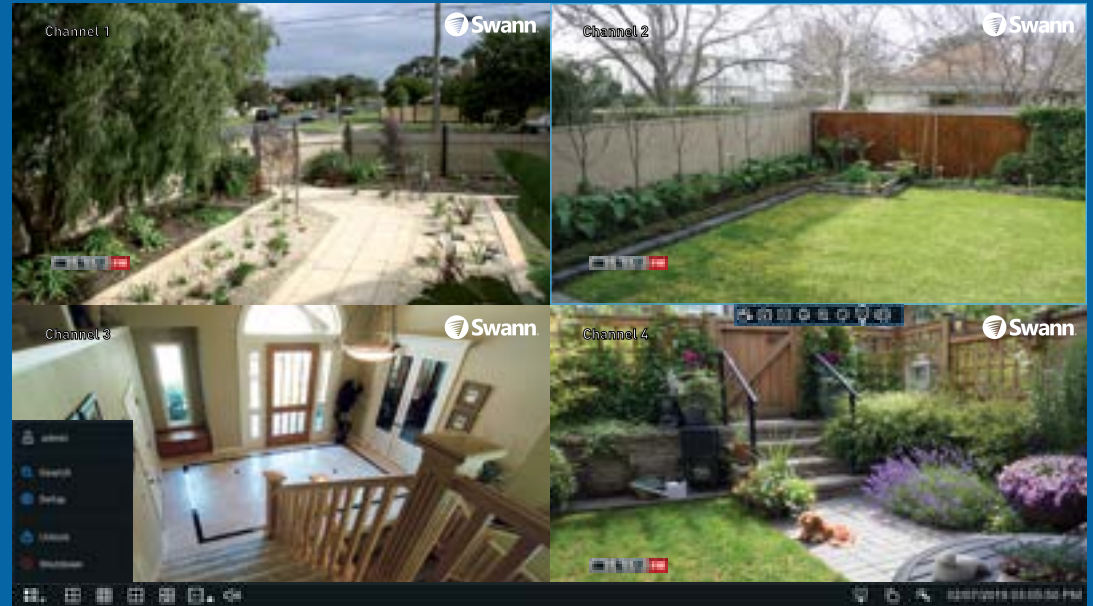

Live View Mode

Live View mode is the default display for your DVR. Each camera connected will be displayed (multiple view modes available). You can check the operation of your DVR by using the status icons on the Live View screen. The date and time as well as the name for each camera is also displayed.

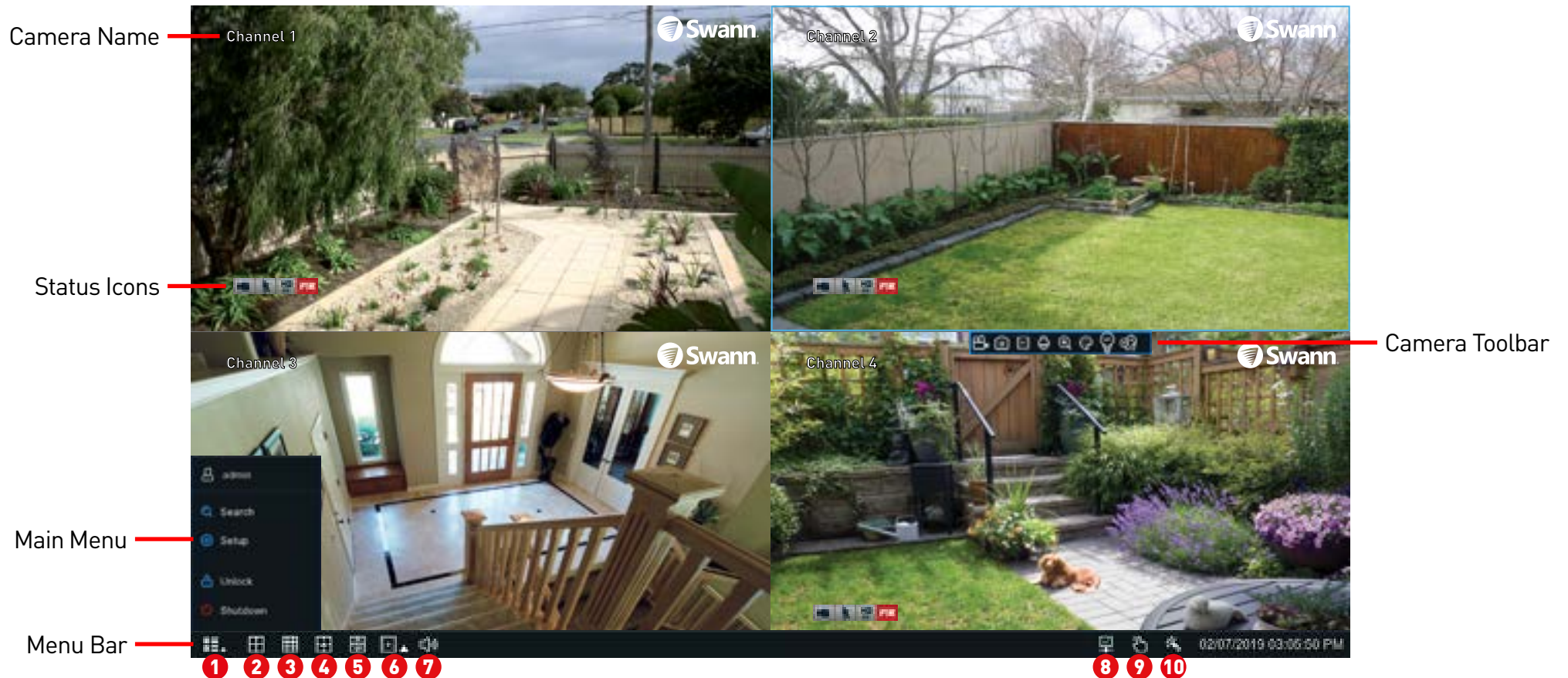

Double-click a live video channel to view full-screen.



Click & drag a live video channel to reposition it.

Right-click the mouse in Live View mode to display the Menu Bar (see [page 8](#) more information).

The Camera Toolbar provides access to functions such as instant playback and image settings (see [page 8](#) more information).

Live View Controls

Menu Bar

1. This is the Start button. Click to reveal additional functions available (see dialogue box below).
2. Four camera view.
3. Nine camera view (this will display eight cameras on the 8 channel model).
4. Click this to select from one of the multi-screen viewing modes available.
5. Click this to repeatedly cycle through each video channel full-screen. Each video channel will be displayed for five seconds.
6. Click the larger button to access the Search menu. From here you can play previously recorded videos. Click the smaller button to play recent events (up to the last five minutes).

Main Menu

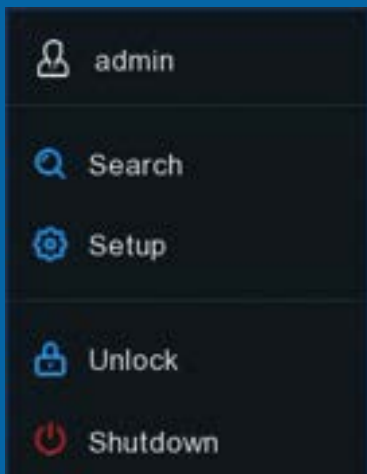

Search: Click to search and play recorded videos (hard drive & USB), view snapshots, and access system log files.

Setup: Click to access the Main Menu.

Unlock: Click to unlock your DVR. If the Menu Timeouts function is disabled, click to lock your DVR to prevent access.

Shutdown: Click to shutdown, reboot or logout of your DVR. Always shutdown your DVR when disconnecting the power.

7. Click this to change the volume or mute the audio (click the speaker icon to mute).
8. This icon indicates that your DVR is connected to your modem or Wi-Fi using the supplied Ethernet cable.
9. Click this to enter Manual Record mode. When enabled this will bypass the current recording schedule.
10. Click this to enter the Startup Wizard.



TIP

The 16 channel model has additional camera views available (twelve and sixteen camera views).

Camera Toolbar

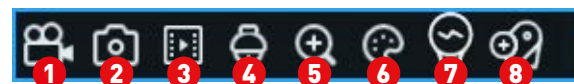

To access the camera toolbar, left-click a camera to display.

1. While viewing the camera, click to start a manual recording (the icon will turn red indicating that it is recording). Click again to stop.
2. Click to take a snapshot.
3. Click to play back the last recording saved (recording must be saved in the last five minutes).

4. Click to access controls for the camera's on-screen display and to control a PTZ camera.

5. Click to enter Zoom mode.
6. Click to adjust image settings.
7. Click to enable the camera's siren and spotlight (if supported).
8. Click to add a Tag when recording. Tagging allows you to record information within the video.

Live View Icons

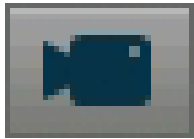

This icon indicates that the camera is being recorded (either manually or by motion).



This icon indicates that your DVR is detecting motion from the camera.



This icon indicates that the camera's native recording resolution is set to 1080p.



This icon indicates that the camera's native recording resolution is set to 5 megapixel.



This icon indicates that the camera's native recording resolution is set to 4K.



This icon indicates that the PIR sensor has detected one or more warm objects.



This icon indicates that an event has occurred via one of the analytic functions (the DVR isn't recording).



This icon indicates that an event has occurred via one of the analytic functions (the DVR is recording).



This icon indicates that your DVR does not have a storage device connected.



This message indicates that the channel doesn't have a camera connected or has lost the feed from its camera.

Live View Digital Zoom Mode

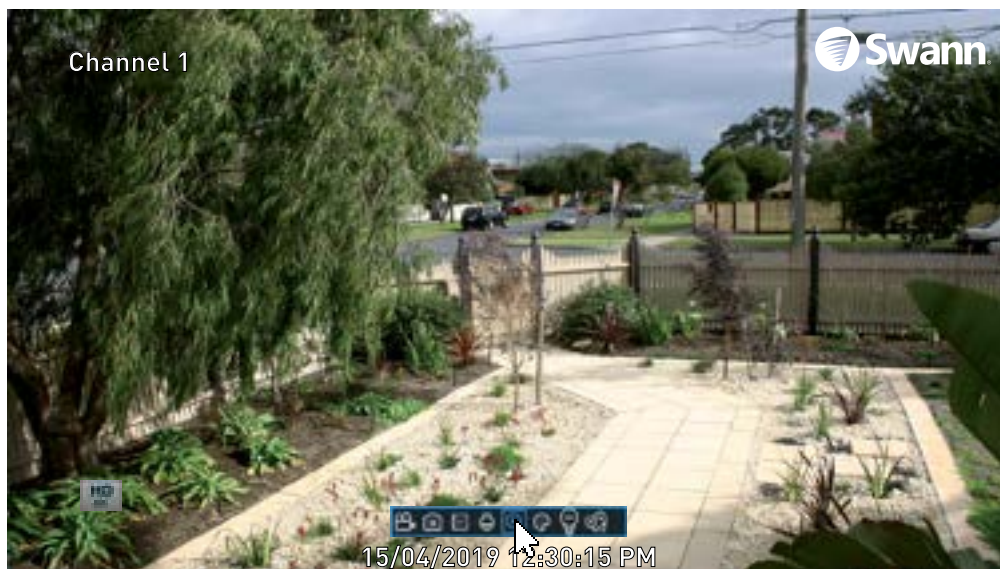

1. To enter Zoom mode, left-click a camera in Live View mode then click the “Zoom” button on the Camera Toolbar (as shown on the left).

2. To zoom, move the mouse to the area or object that you want to zoom to then use the scroll wheel on the mouse to zoom in or out. When zoomed in, click and hold the rectangle (as shown bottom right of the screen) to scroll around the image. Right-click to exit.

Double-click the mouse to view multiple cameras.

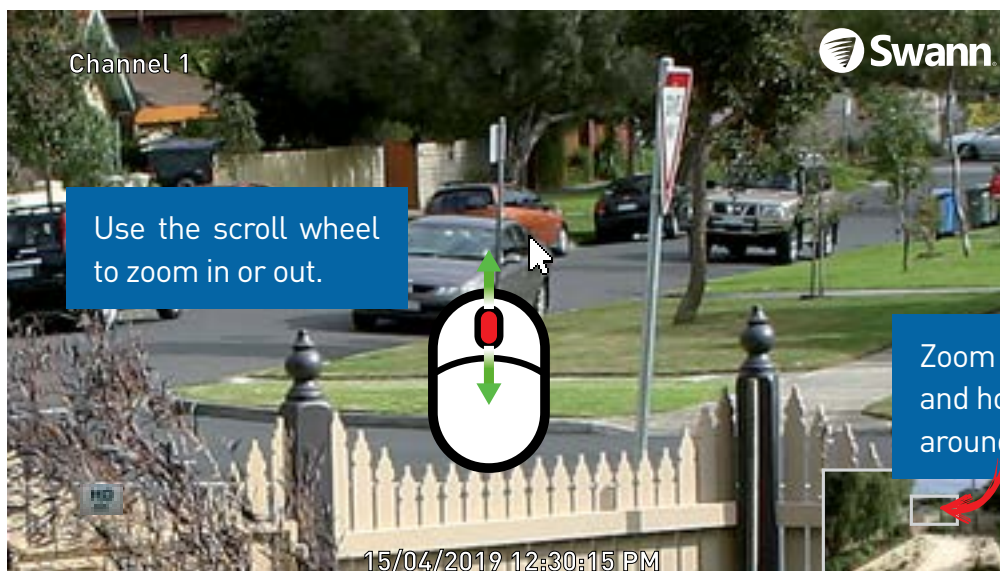

Main Menu

The Main Menu is where you control the various actions and options that are available on your DVR. Functions such as Privacy Zone can be enabled to obscure all or part of your image, and the option to change the default motion detection area. You can also enable Cloud Storage to copy snapshots and video to the cloud when events occur. To maintain system integrity, a firmware upgrade can be performed when available.

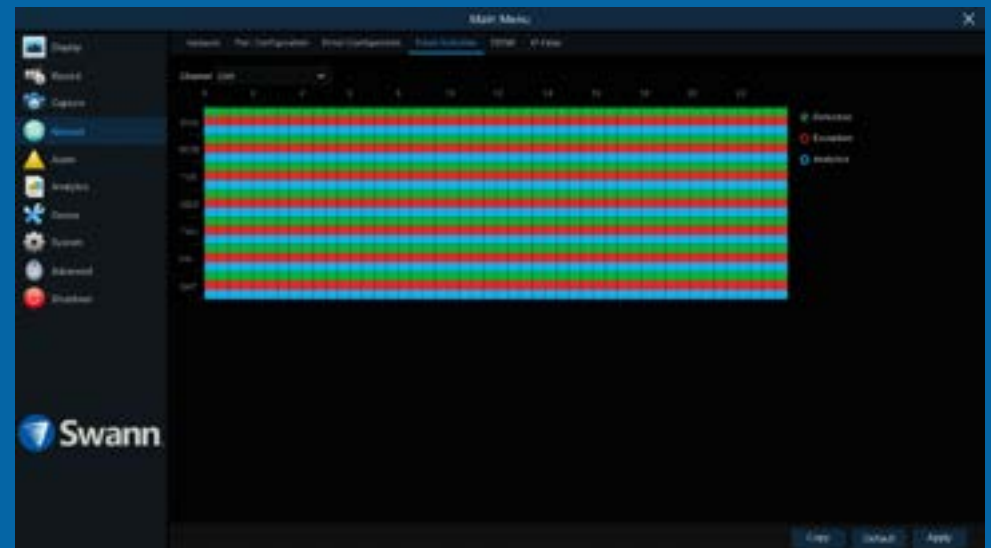
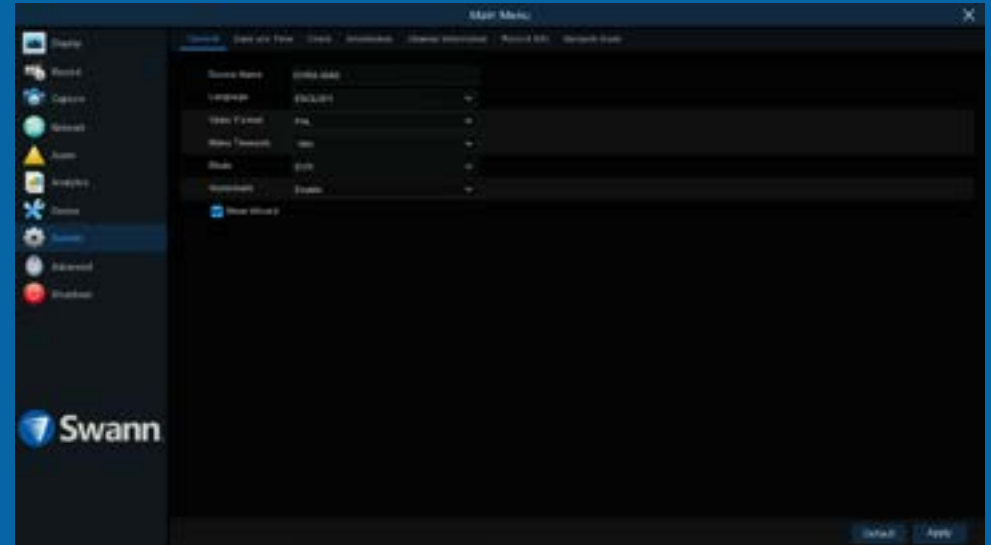

Menu Layout

The various functions and options available, are categorised on the left-hand side of the Menu.

Clicking each category will reveal a number of tabs or sub-categories that can be changed from their default setting.

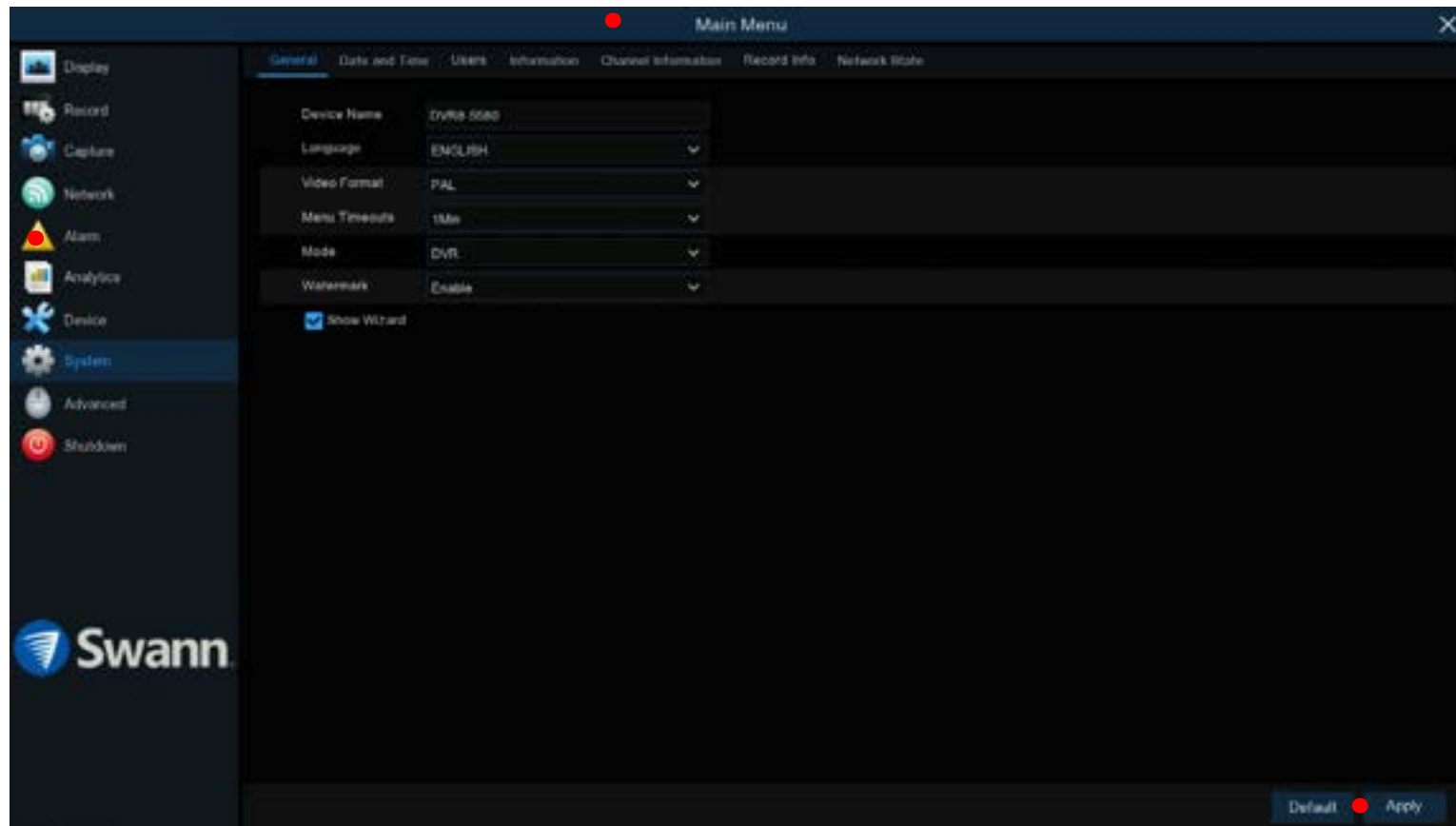

To exit or access the previous menu, right-click the mouse.



Save changes that have been made or restore default settings.



Camera Configuration

The camera configuration options are available in the Display, Record, Alarm and Device menus that are accessible from the Main Menu. You can change the resolution, bitrate, OSD (on-screen display) position as well as image settings for hue, brightness, contrast and saturation. Your DVR has controls for detecting motion, allowing you to define specific areas to alert you to a potential threat in and around your home. You also have the ability to create one or more zones for privacy and setting a schedule for the camera's sensor warning light and siren (if supported).

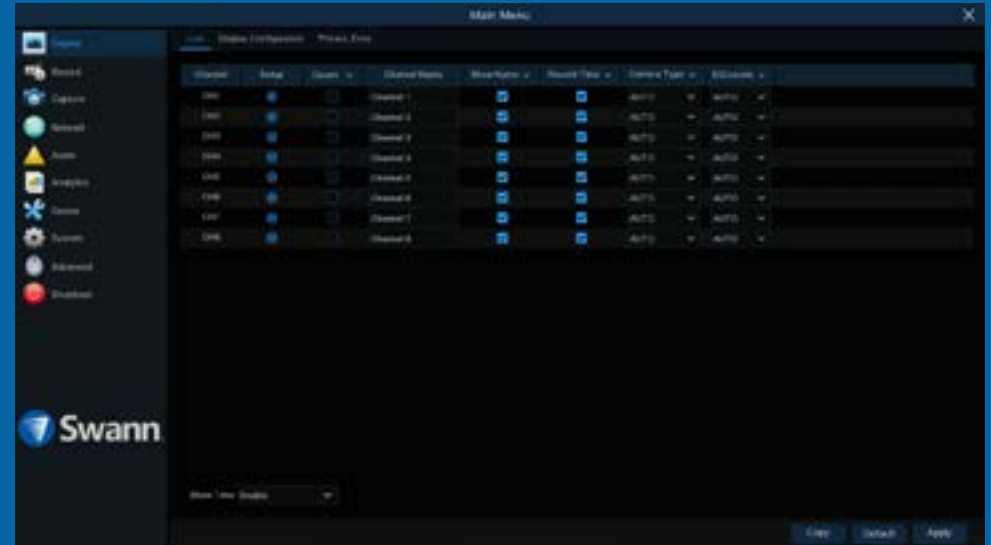

Display: Live

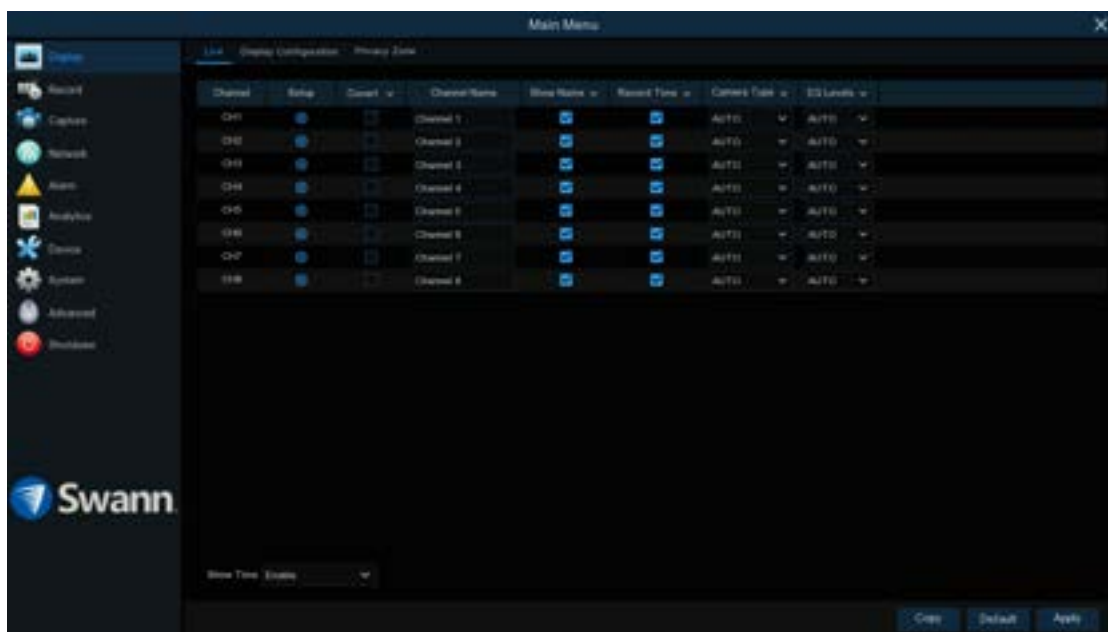

The configuration options available allow you to name each camera relevant to where it has been installed as well as the ability to adjust image settings such as brightness and contrast. You can also enable covert mode to hide the camera's image in Live View mode.

- Use the "Copy" function to apply all settings to the other cameras connected.
- Click "Default" to revert to default settings.
- Click "Apply" to save settings.

Each camera input on your DVR will be displayed as CH1, CH2, etc.

Setup: Click the button to access the camera display settings:

Channel: Select a camera that you would like to edit.

Channel Name: Enter a name for the camera selected. It can be up to 16 characters in length.

Camera Type: This setting is used to instruct your DVR on the camera type connected. For the cameras included with your DVR, leave the default setting. However, if you are connecting cameras that you have purchased previously or upgrading from an older security system and the image is black & white, change this to TVI or AHD, depending on your camera type. Click the drop down menu then select the camera type for your camera.

EQ Levels: Can be used to compensate for any discrepancies that might be visible in the image quality. This may occur when using extra-long coaxial cables or if there is interference from electrical wiring or other power sources. The discrepancy may look like an old TV set that has bad reception. Click the drop down menu and change the level in small doses until you are satisfied with the image quality.

Covert: When enabled, the camera will detect motion and trigger your DVR to record, but you will not see an image of the camera in Live View mode. This may be suitable if your DVR and TV are displayed in a public area (shop, warehouse, etc.), but you don't want others to see an image from the camera.

(continued on next page)

Display: Live

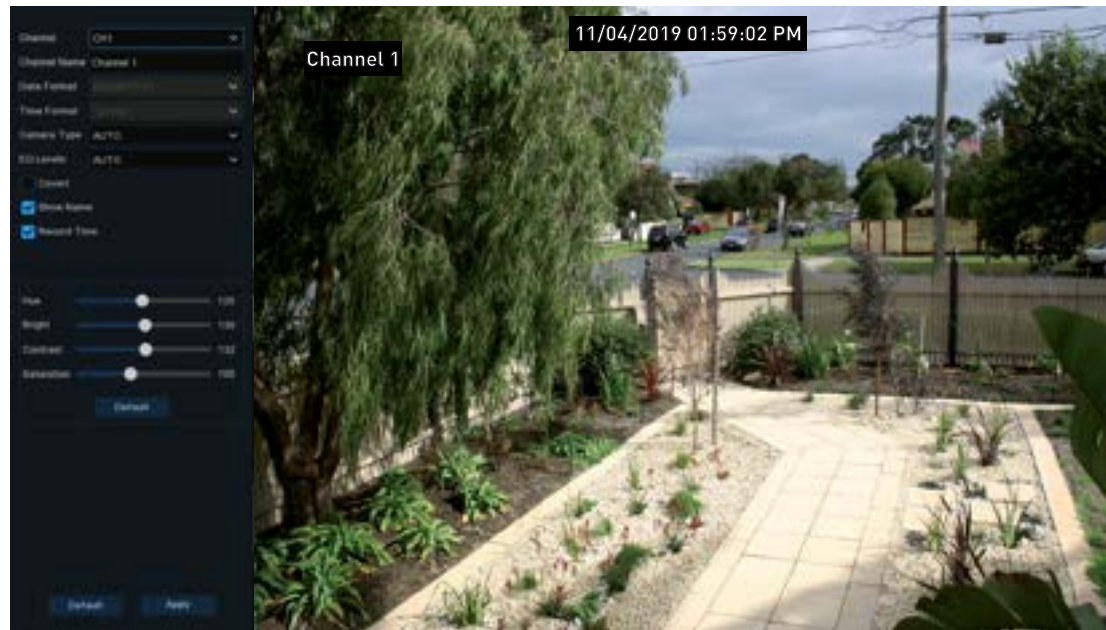

Show Name: Leave this enabled to display the camera name in Live View mode, otherwise click the checkbox to disable.

Record Time: Leave this enabled, as a timestamp will be embedded on all video recordings. This allows you to easily identify when events have occurred. Click the checkbox if you wish to disable.

Hue: This changes the color mix of the image.

Bright: This changes how light the image appears to be.

Contrast: This increases the difference between the blackest black and the whitest white in the image.

Saturation: This alters how much color is displayed in the image.

Use the slider to adjust each setting. When finished, click the "Apply" button

then click "OK". Right-click the mouse to exit.

Show Time: Leave this enabled to display the date & time in Live View mode, otherwise click the checkbox to disable.



TIP

Any changes made to the display settings available will affect your recordings.

Display: Privacy Zone

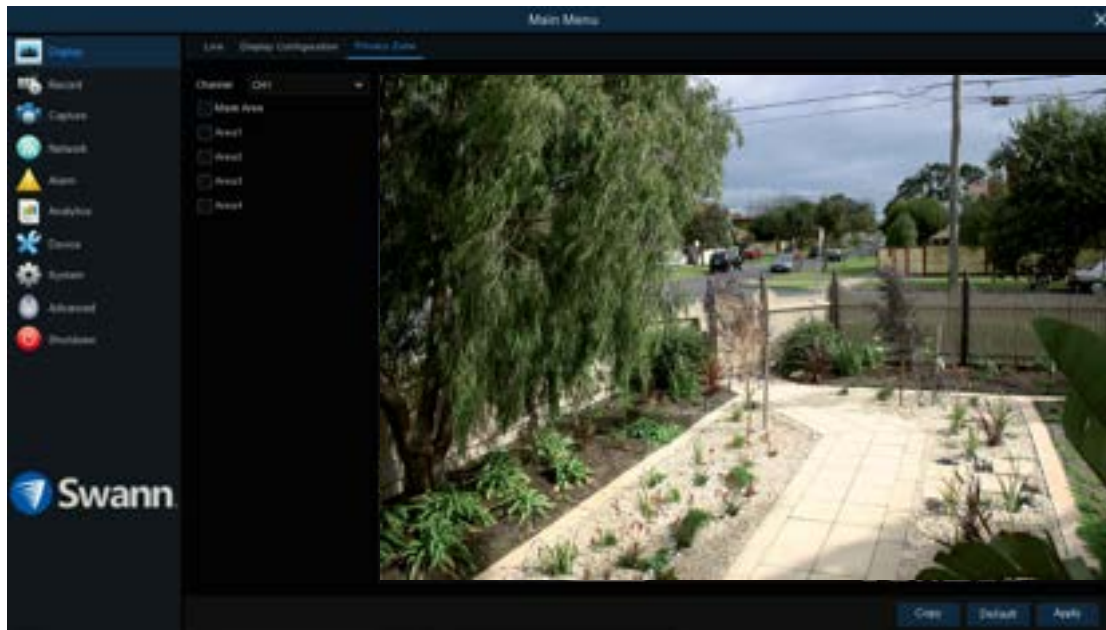

This function can be used to obscure all or part of your image for privacy (up to four privacy masks can be created per camera). You can also use this to minimize false triggers when motion is detected. Areas obscured by a mask won't be shown live or recorded.

- Use the “Copy” function to apply all settings to the other cameras connected.
- Click “Default” to revert to default settings.
- Click “Apply” to save settings.

Channel: Select a camera that you would like to edit.

Mask Area: To create a mask, click the checkbox to enable.

Area 1 to 4: Click the checkbox on the number of privacy masks that you want to enable. Up to four privacy masks can be enabled per camera.

Depending on the number of privacy masks enabled, one or more masks will appear in the Live View windows (see page 18 - [Enabling a Privacy Mask](#)).

Enabling a Privacy Mask

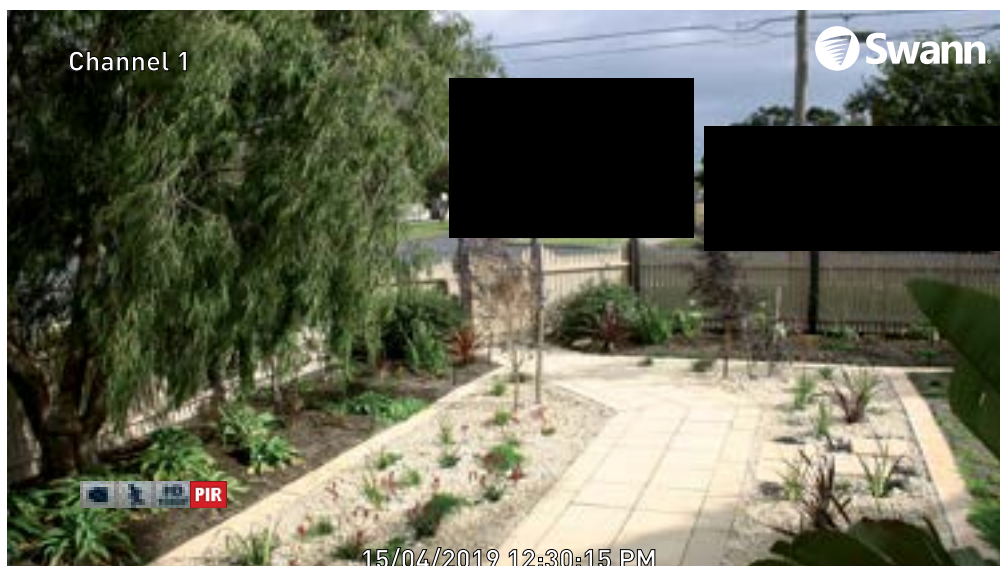
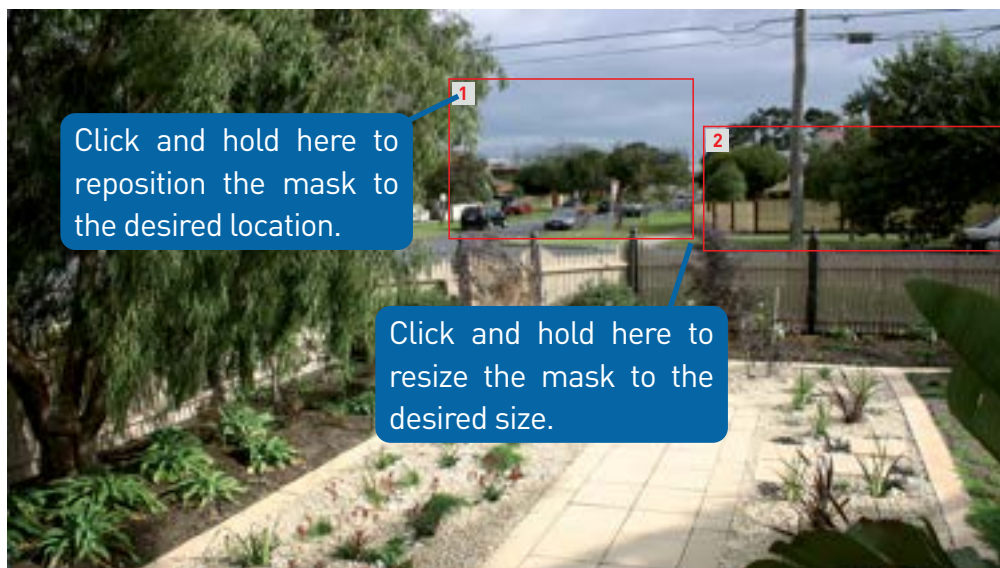

1. Depending on the number of masks that you want to enable, each mask will be numbered. To reposition the mask, click and hold the mask number then move the mask to the desired location.

2. To resize the mask, click and hold the bottom right corner of the mask then resize to the desired size. You can reposition and resize each mask to overlap each other.

In the example provided on the left, two masks have been enabled to block out cars and pedestrians adjacent to the front yard of the house. This will minimise false triggers and block movement that is not relevant to entry via the front entrance.

3. When finished, click “Apply” to save. Areas obscured by a mask won’t be shown live or recorded (see below left).

To remove a mask, uncheck the checkbox next to the relevant area then click “Apply” to save.

Record: Mainstream (4K Series & 4K Ready)

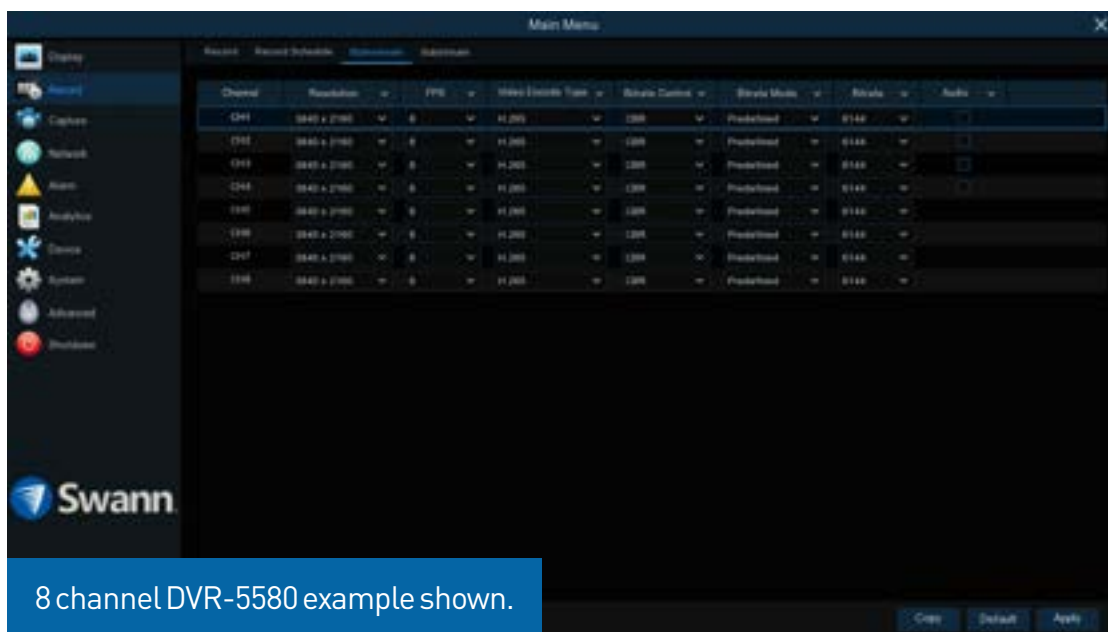

8 channel DVR-5580 example shown.

The functions available here allow you to change the bitrate and bitrate mode for each camera connected. By default, the recording resolution and frame rate are automatically selected to fit in with the capabilities of the provided cameras connected.

- Use the “Copy” function to apply all settings to the other cameras connected.
- Click “Default” to revert to default settings.
- Click “Apply” to save settings.

Each camera input on your DVR will be displayed as CH1, CH2, etc.

Resolution: By default, the recording resolution is automatically selected to match the capabilities of the provided cameras connected. Changing the resolution has no bearing on the event recorded to the DVR’s storage device.

FPS: The number of frames per second (fps) that your DVR will record. Frame rate is the frequency at which consecutive images called frames appear on a display and will impact the viewing experience when playing back an event. The maximum frame rate of your DVR will be shown.

Video Encode Type: Your DVR utilizes two encoding methods to record video. The default method of compression is H.265. This will result in less hard drive space used when recording (before older videos are automatically overwritten). The second method of compression is H.264. This is a commonly used

format for recording and compressing video and is used in Blu-ray players and to broadcast TV signals. If visual quality is of importance, change this to H.264, otherwise leave the default selection.

Bitrate Control: CBR (Constant Bitrate) utilizes a fixed bitrate and bandwidth to record video. This means your DVR will use the same number of bits throughout the entire recording, regardless of what is happening on-screen. VBR (Variable Bitrate) utilizes a bitrate and bandwidth that changes when your DVR is recording. The bitrate will increase or decrease depending on how complex the scene is.

(continued on next page)

Record: Mainstream (4K Series & 4K Ready)

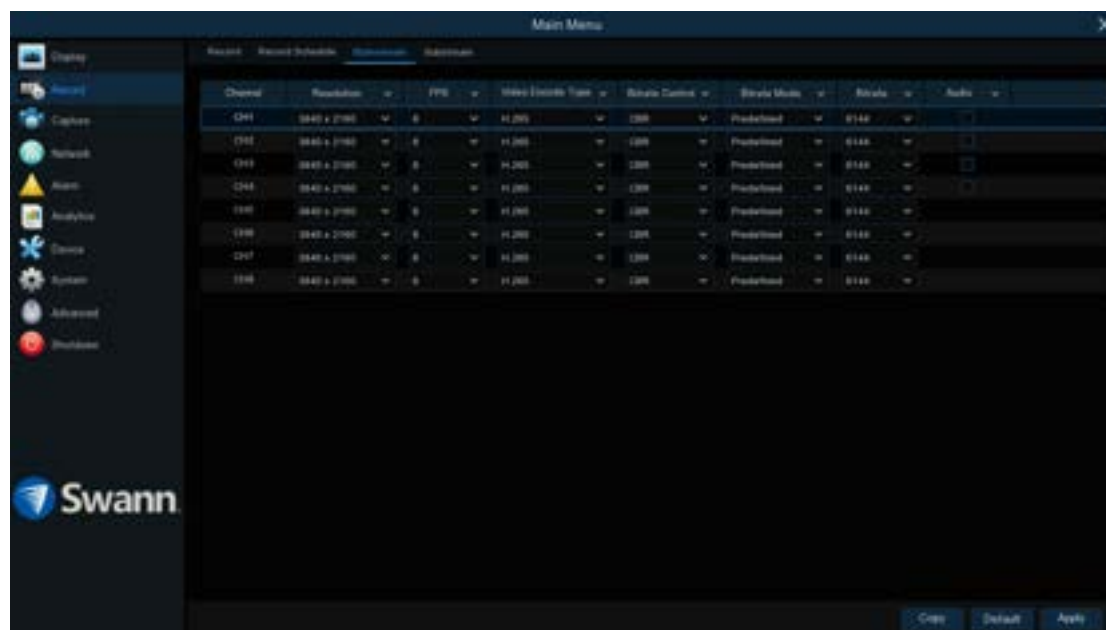

Which method should I choose? Scene complexity can vary significantly over several hours of recorded video, and the bitrate you select will have an effect on image quality, bandwidth consumption, and hard drive storage. A complex scene with moving action, will affect image quality and bandwidth consumption more than a less complex scene with little action or movement.

CBR (Constant Bitrate): If you have cameras placed in high traffic areas, CBR is the recommended control method. As the bitrate is fixed, the image quality will be consistent and will assist when identifying people or objects.

VBR (Variable Bitrate): If you have cameras placed in low traffic areas, VBR is the recommended control method. As the bitrate is variable, your DVR can use a lower bitrate if there is little to no movement detected.

When choosing VBR, you can select the recording quality that will define the

variable bitrate used. You can select from lowest to highest.

Bitrate Mode: You have the choice of selecting a predefined or user-defined bitrate. For most instances, the default selection will be suitable.

Bitrate: The amount of data that your DVR will use to record video. A high bitrate will increase the overall video quality, but will increase the need for more data traffic and each recording will consume more space on the hard drive. The default bitrate of your DVR will be shown.

Audio: Click the checkbox if you have an audio source connected to the DVR's audio input(s). For some DVR models, this option is on camera input 1 only.



TIP

Selecting the appropriate recording settings is dependent on camera location, lighting conditions and the level of quality required.

Record: Mainstream (3K Series)

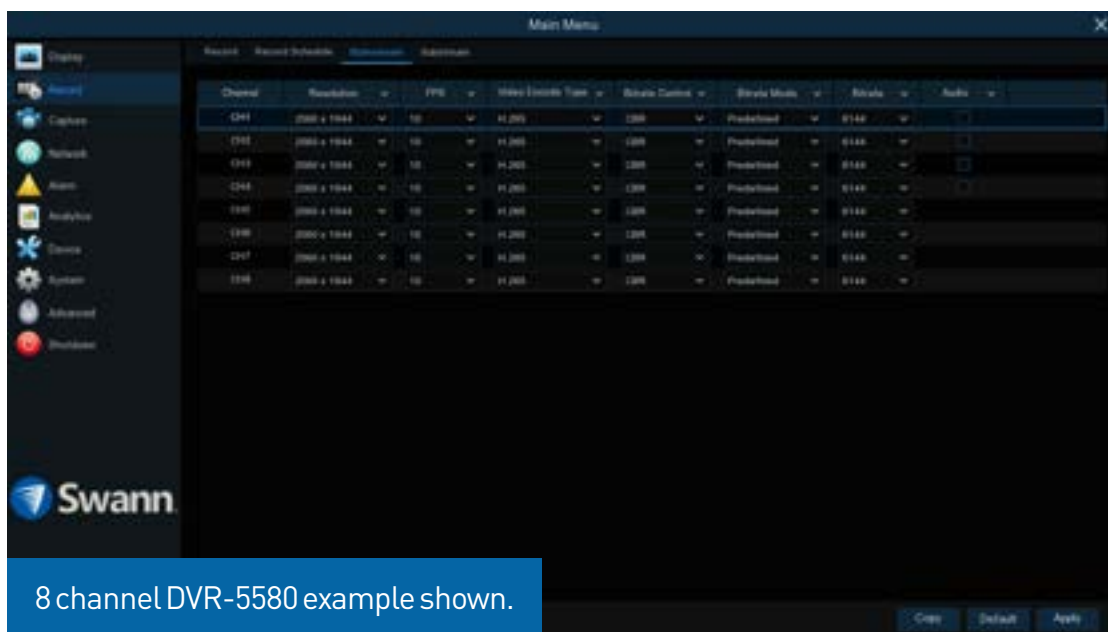

8 channel DVR-5580 example shown.

The functions available here allow you to change the bitrate and bitrate mode for each camera connected. By default, the recording resolution and frame rate are automatically selected to fit in with the capabilities of the provided cameras connected.

- Use the “Copy” function to apply all settings to the other cameras connected.
- Click “Default” to revert to default settings.
- Click “Apply” to save settings.

Each camera input on your DVR will be displayed as CH1, CH2, etc.

Resolution: By default, the recording resolution is automatically selected to match the capabilities of the provided cameras connected. Changing the resolution has no bearing on the event recorded to the DVR’s storage device.

FPS: The number of frames per second (fps) that your DVR will record. Frame rate is the frequency at which consecutive images called frames appear on a display and will impact the viewing experience when playing back an event. The maximum frame rate of your DVR will be shown.

Video Encode Type: Your DVR utilizes two encoding methods to record video. The default method of compression is H.265. This will result in less hard drive space used when recording (before older videos are automatically overwritten). The second method of compression is H.264. This is a commonly used

format for recording and compressing video and is used in Blu-ray players and to broadcast TV signals. If visual quality is of importance, change this to H.264, otherwise leave the default selection.

Bitrate Control: CBR (Constant Bitrate) utilizes a fixed bitrate and bandwidth to record video. This means your DVR will use the same number of bits throughout the entire recording, regardless of what is happening on-screen. VBR (Variable Bitrate) utilizes a bitrate and bandwidth that changes when your DVR is recording. The bitrate will increase or decrease depending on how complex the scene is.

(continued on next page)

Record: Mainstream (3K Series)

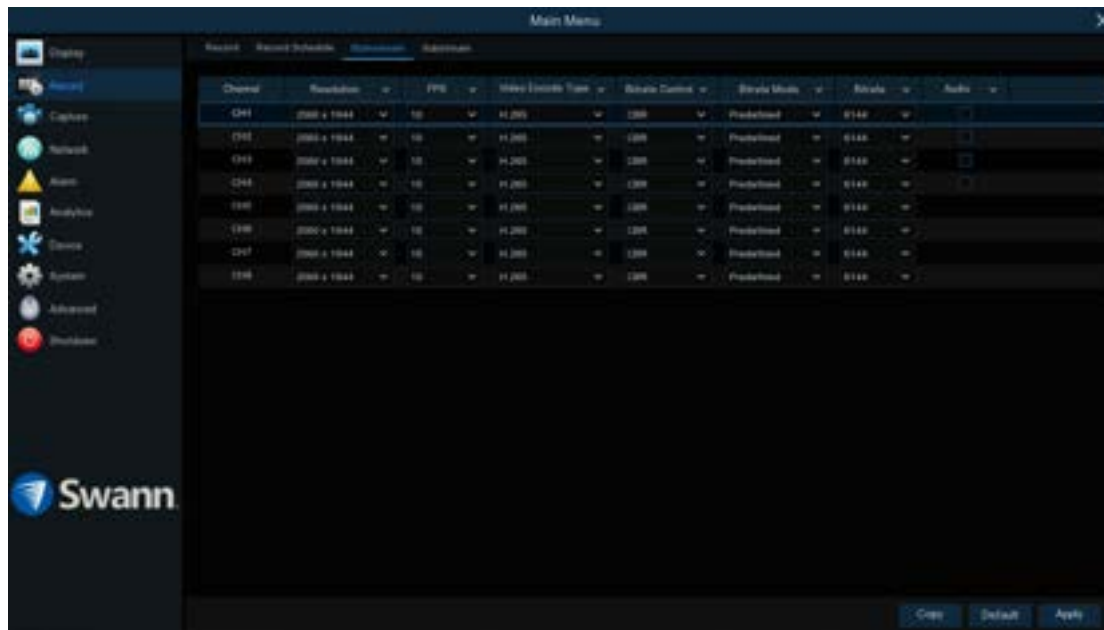

Which method should I choose? Scene complexity can vary significantly over several hours of recorded video, and the bitrate you select will have an effect on image quality, bandwidth consumption, and hard drive storage. A complex scene with moving action, will affect image quality and bandwidth consumption more than a less complex scene with little action or movement.

CBR (Constant Bitrate): If you have cameras placed in high traffic areas, CBR is the recommended control method. As the bitrate is fixed, the image quality will be consistent and will assist when identifying people or objects.

VBR (Variable Bitrate): If you have cameras placed in low traffic areas, VBR is the recommended control method. As the bitrate is variable, your DVR can use a lower bitrate if there is little to no movement detected.

When choosing VBR, you can select the recording quality that will define the

variable bitrate used. You can select from lowest to highest.

Bitrate Mode: You have the choice of selecting a predefined or user-defined bitrate. For most instances, the default selection will be suitable.

Bitrate: The amount of data that your DVR will use to record video. A high bitrate will increase the overall video quality, but will increase the need for more data traffic and each recording will consume more space on the hard drive. The default bitrate of your DVR will be shown.

Audio: Click the checkbox if you have an audio source connected to the DVR's audio input(s). For some DVR models, this option is on camera input 1 only.



TIP

Selecting the appropriate recording settings is dependent on camera location, lighting conditions and the level of quality required.

Record: Mainstream (2K Series)

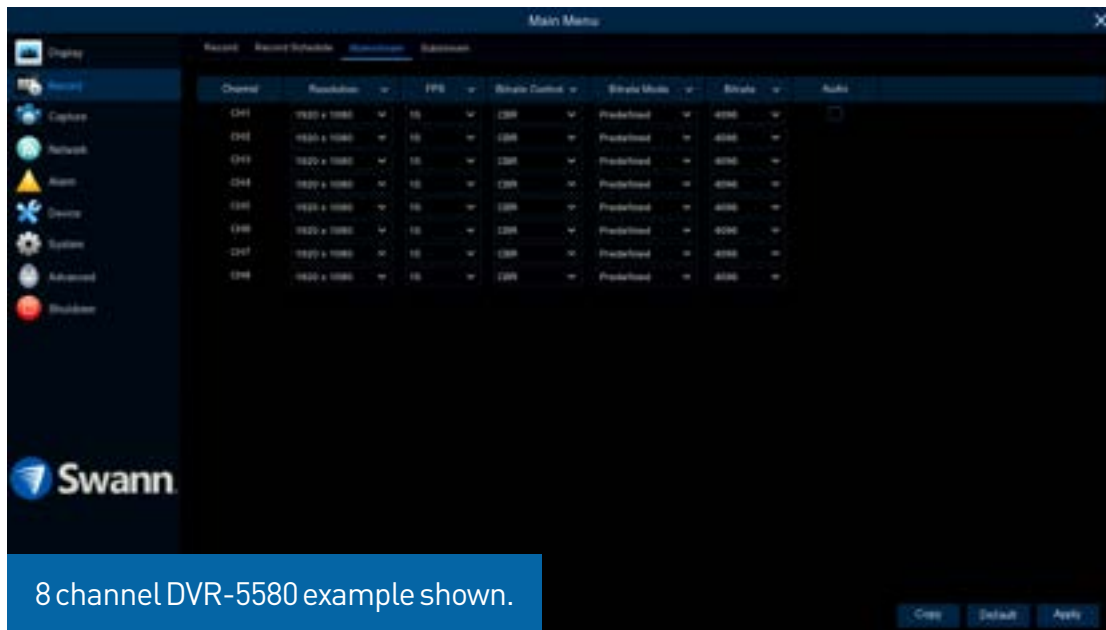

8 channel DVR-5580 example shown.

The functions available here allow you to change the bitrate and bitrate mode for each camera connected. By default, the recording resolution and frame rate are automatically selected to fit in with the capabilities of the provided cameras connected.

- Use the “Copy” function to apply all settings to the other cameras connected.
- Click “Default” to revert to default settings.
- Click “Apply” to save settings.

Each camera input on your DVR will be displayed as CH1, CH2, etc.

Resolution: By default, the recording resolution is automatically selected to match the capabilities of the provided cameras connected. Changing the resolution has no bearing on the event recorded to the DVR’s storage device.

FPS: The number of frames per second (fps) that your DVR will record. Frame rate is the frequency at which consecutive images called frames appear on a display and will impact the viewing experience when playing back an event. The maximum frame rate of your DVR will be shown.

Video Encode Type: Your DVR utilizes two encoding methods to record video. The default method of compression is H.265. This will result in less hard drive space used when recording (before older videos are automatically overwritten). The second method of compression is H.264. This is a commonly used

format for recording and compressing video and is used in Blu-ray players and to broadcast TV signals. If visual quality is of importance, change this to H.264, otherwise leave the default selection.

Bitrate Control: CBR (Constant Bitrate) utilizes a fixed bitrate and bandwidth to record video. This means your DVR will use the same number of bits throughout the entire recording, regardless of what is happening on-screen. VBR (Variable Bitrate) utilizes a bitrate and bandwidth that changes when your DVR is recording. The bitrate will increase or decrease depending on how complex the scene is.

(continued on next page)

Record: Mainstream (2K Series)

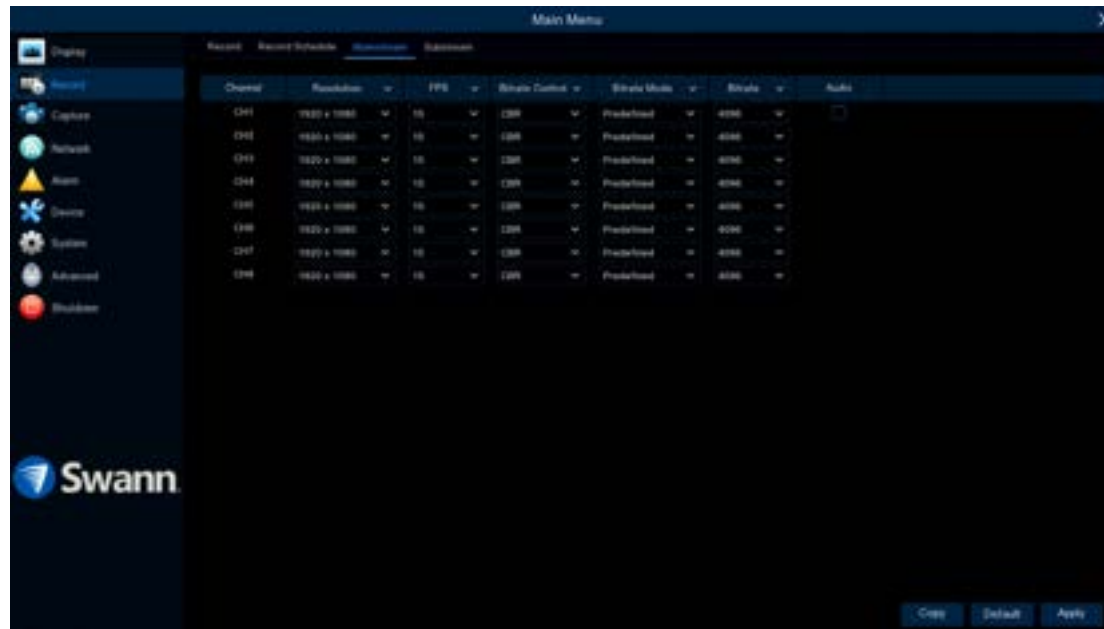

VBR: If you have cameras placed in low traffic areas, VBR is the recommended control method. As the bitrate is variable, your DVR can use a lower bitrate if there is little to no movement detected.

When choosing VBR, you can select the recording quality that will define the variable bitrate used. You can select from lowest to highest.

Bitrate Mode: You have the choice of selecting a predefined or user-defined bitrate. For most instances, the default selection will be suitable.

Bitrate: The amount of data that your DVR will use to record video. A high bitrate will increase the overall video quality, but will increase the need for more data traffic and each recording will consume more space on the hard drive. The default bitrate of your DVR will be shown.

Audio: Click the checkbox if you have an audio source connected to the DVR's

audio input(s). For some DVR models, this option is on camera input 1 only.



TIP

Selecting the appropriate recording settings is dependent on camera location, lighting conditions and the level of quality required.

Record: Substream

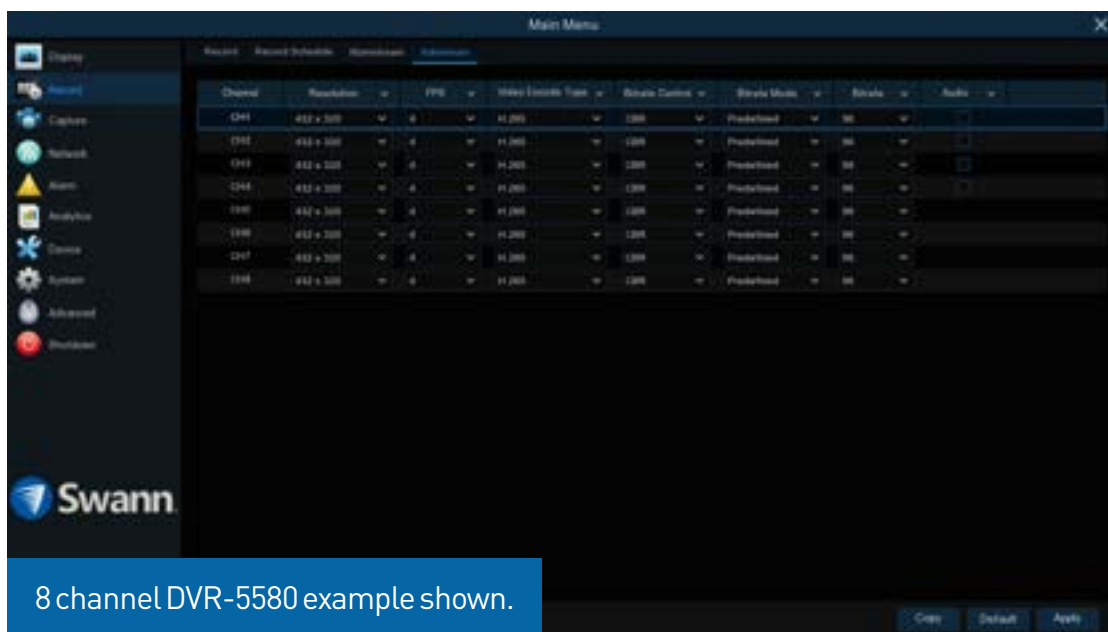

8 channel DVR-5580 example shown.

The functions available here allow you to control how video is streamed to your mobile device when using the Swann Security app. You can change the frame rate, bitrate mode, and bitrate control if you're having issues streaming live video from your DVR.

- Use the "Copy" function to apply all settings to the other cameras connected.
- Click "Default" to revert to default settings.
- Click "Apply" to save settings.

Each camera input on your DVR will be displayed as CH1, CH2, etc.

Resolution: The default resolution is 432 x 320 (4K & 3K Series) and 352 x 240 (2K Series). For the 4K & 3K Series, you can select a lower resolution if you're having issues streaming to your mobile device via the Swann Security app (especially when viewing multiple cameras), or you can also increase the resolution if you would like greater clarity.

FPS: The number of frames per second (fps) that your DVR will process when streaming to your mobile device via the Swann Security app. For most instances, the default frame rate will be suitable. Increase the frame rate for cameras that monitor medium to high traffic areas. This results in smoother motion but may require the use of a higher bitrate.

Video Encode Type (4K & 3K Series): Your DVR utilizes two encoding meth-

ods to record video. The default method of compression is H.265. This will result in less hard drive space used when recording (before older videos are automatically overwritten). The second method of compression is H.264. This is a commonly used format for recording and compressing video and is used in Blu-ray players and to broadcast TV signals. If visual quality is of importance, change this to H.264, otherwise leave the default selection.

Bitrate Control: Change this to VBR. This will result in a lower recording size as well as a lower bandwidth requirement. You can select the recording quality that will define the variable bitrate used, from lowest to highest.

Bitrate Mode: You have the choice of selecting a predefined or user-defined bitrate. For most instances, the default selection will be suitable.

(continued on next page)

Record: Substream

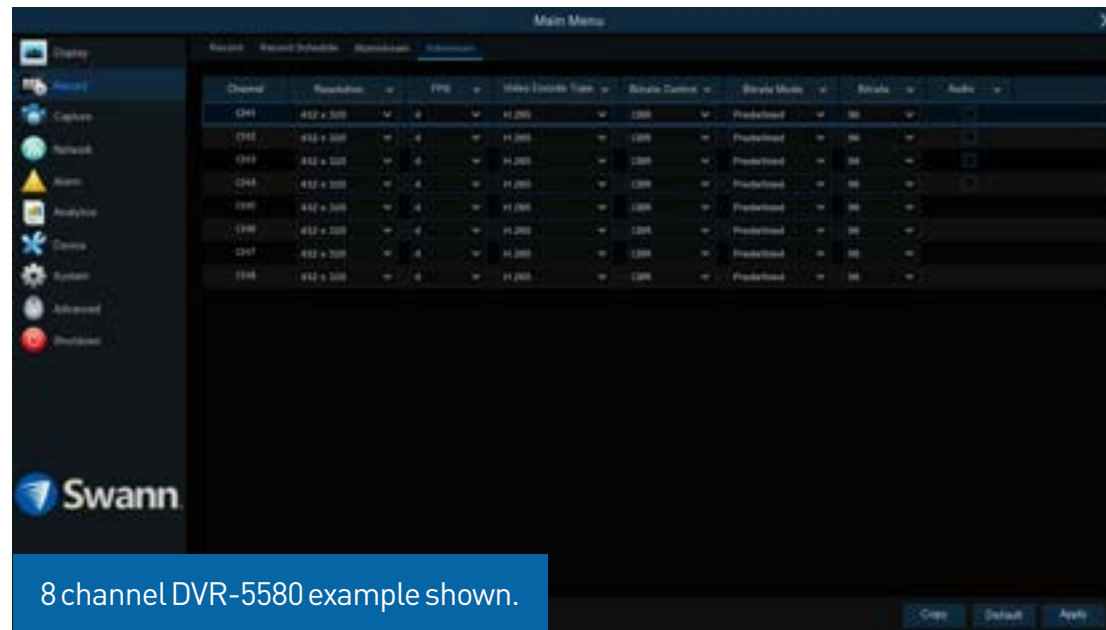

Bitrate: The amount of data that your DVR will use to stream video to your mobile device. For cameras that monitor medium to high traffic areas, increase the bitrate to add more detail to the camera's image, but just be aware this will increase the network or data bandwidth required. Increase the bitrate in small doses until you are satisfied with the image quality.

Audio: Click the checkbox if you have an audio source connected to the DVR's audio input(s). For some DVR models, this option is on camera input 1 only.



TIP

When streaming live video, the quality is dependent on your internet connection and the Substream settings utilized. This is important to remember when streaming multiple cameras at the same time.

Alarm: Detection (4K, 3K & 2K Series)

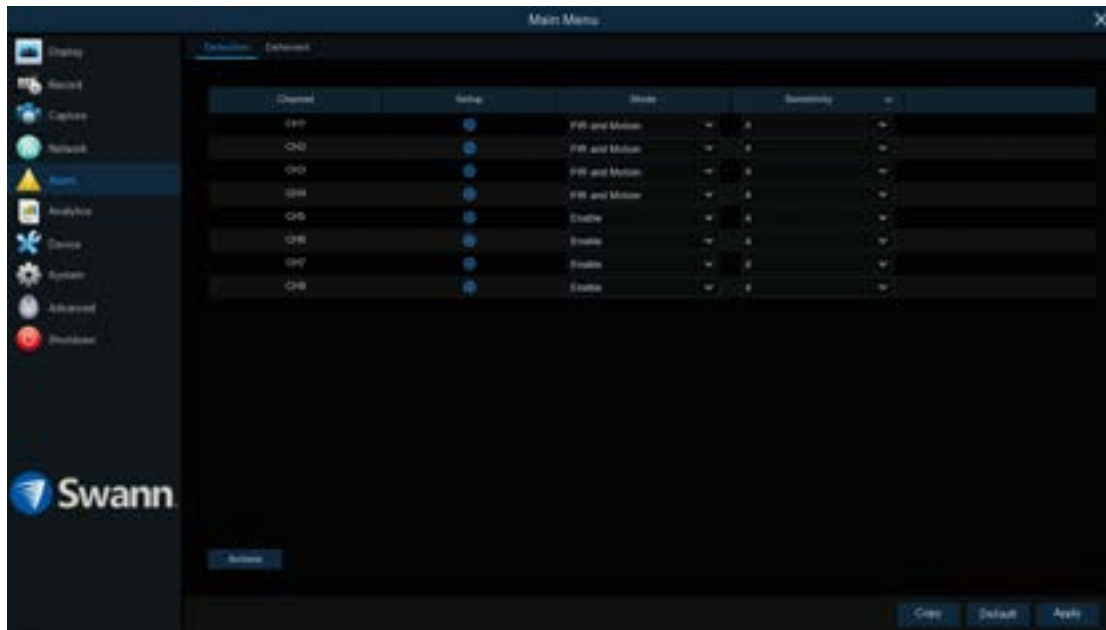

When motion has been detected by one or more cameras, your DVR will alert you to a potential threat at your home. It does this by sending you an email alert with an attached image from the camera to use as a reference (if this option is enabled) and/or sending push notifications via the Swann Security app.

- Use the “Copy” function to apply all settings to the other cameras connected.
- Click “Default” to revert to default settings.
- Click “Apply” to save settings.

Each camera input on your DVR will be displayed as CH1, CH2, etc.

Setup: Click the button to change the default motion detection area. The entire view of the camera is enabled for motion detection, however you can select certain areas if you wish (see page 31 - [Motion Detection Setup](#)).

Mode: By default, your DVR will record motion only if one or more objects have been detected by the camera and the camera’s built-in PIR sensor. This provides more accurate motion detection by eliminating false triggers due to wind, leaves falling and rain (see page 33 - [Thermal-Sensing Camera Tips](#)). If you’re monitoring an area that doesn’t require objects to be detected by the camera’s built-in PIR sensor, such as a busy walkway or a building entrance, change this to “Motion”.

Sensitivity: This option allows you to change the sensitivity level. The higher

the number, the more sensitive your DVR will be when detecting motion. For most instances, the default selection will be suitable, however it’s recommended to conduct a test to see if the sensitivity level is correct for the camera’s location (see page 32 - [Motion Detection Tips](#)).

Actions: Click the button to change options for alarm notifications, alerts and more (see page 29 - [Alarm: Detection - Actions](#)).

Alarm: Detection (4K Ready)

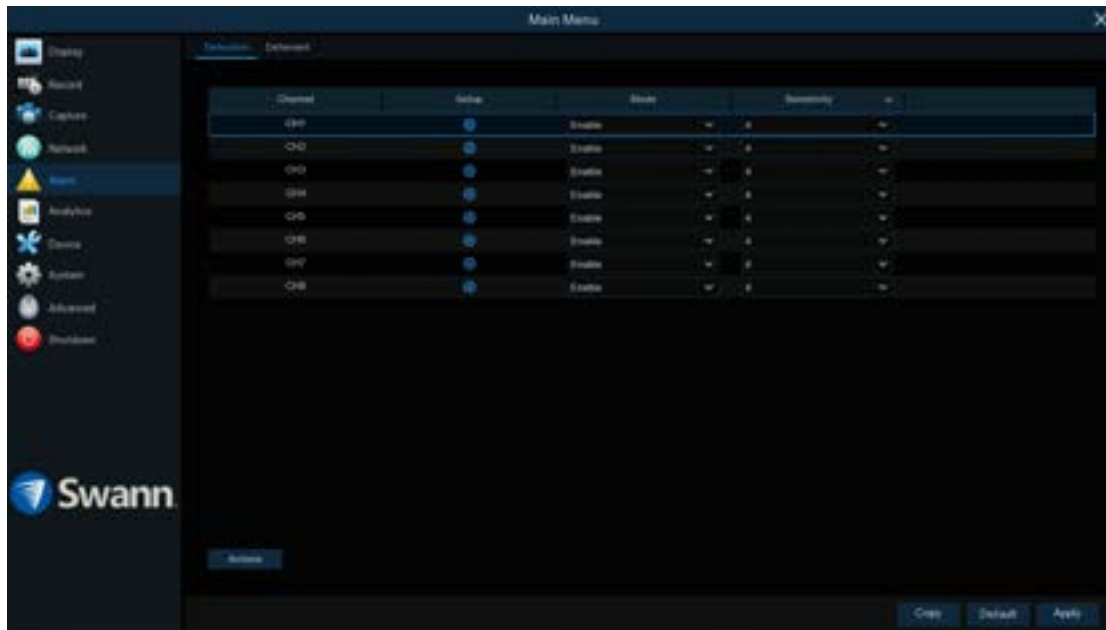

When motion has been detected by one or more cameras, your DVR will alert you to a potential threat at your home. It does this by sending you an email alert with an attached image from the camera to use as a reference (if this option is enabled).

- Use the “Copy” function to apply all settings to the other cameras connected.
- Click “Default” to revert to default settings.
- Click “Apply” to save settings.

Each camera input on your DVR will be displayed as CH1, CH2, etc.

Setup: Click the button to change the default motion detection area. The entire view of the camera is enabled for motion detection, however you can select certain areas if you wish (see page 31 - [Motion Detection Setup](#)).

Mode: By default, your DVR will record motion when one or more objects have been detected by the camera. If for some reason motion detection is not required, you have the option of disabling it.

Sensitivity: This option allows you to change the sensitivity level. The higher the number, the more sensitive your DVR will be when detecting motion. For most instances, the default selection will be suitable, however it's recommended to conduct a test to see if the sensitivity level is correct for the camera's location (see page 32 - [Motion Detection Tips](#)).

Actions: Click the button to change options for alarm notifications, alerts and more (see page 30 - [Alarm: Detection - Actions](#)).

Alarm: Detection - Actions (4K, 3K & 2K Series)

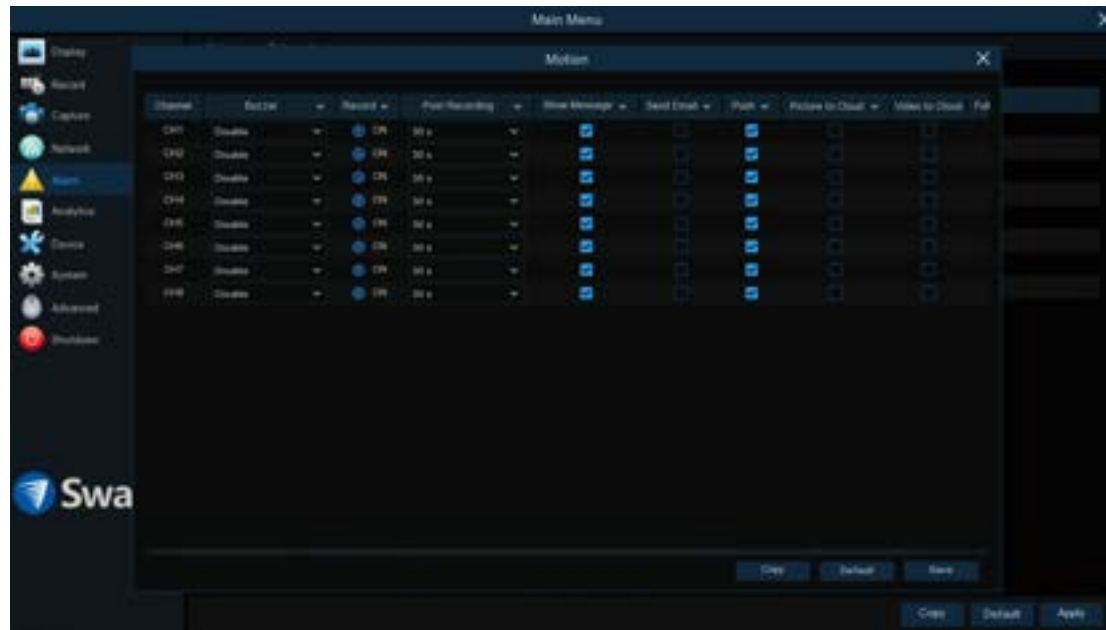

Buzzer: When motion has been detected, you can enable the DVR's buzzer to alert you for a predetermined amount of time. Click the drop down menu to select a time.

Record (Record Channel & Analog Channels): This option instructs your DVR to trigger additional cameras to start recording when motion has been detected. Click the "Analog Channels" checkbox to select all cameras or click on the individual camera number that you want to trigger for recording.

Post Recording: This option instructs your DVR to record for a set period of time after an event has occurred. For most instances, the default selection will be suitable, however you can change this if you wish.

Show Message: When motion has been detected, the motion icon will appear on-screen. Click the checkbox if you want to disable this.

Send Email: Click the checkbox to enable your DVR to send an email alert when motion has been detected.

Push: Push notifications are automatically sent via the Swann Security app. Click the checkbox if you want to disable this.

Picture to Cloud: Click the checkbox to copy snapshots to the cloud via Dropbox (see page 120 - [Device: Cloud Storage](#)).

Video to Cloud: Click the checkbox to copy videos to the cloud via Dropbox (see page 120 - [Device: Cloud Storage](#)).

Full Screen (slide to the right to view): Click the checkbox to view the camera full-screen in Live View mode when motion has been detected.

Click the "Save" button then click "OK". Right-click the mouse to exit.

Alarm: Detection - Actions (4K Ready)

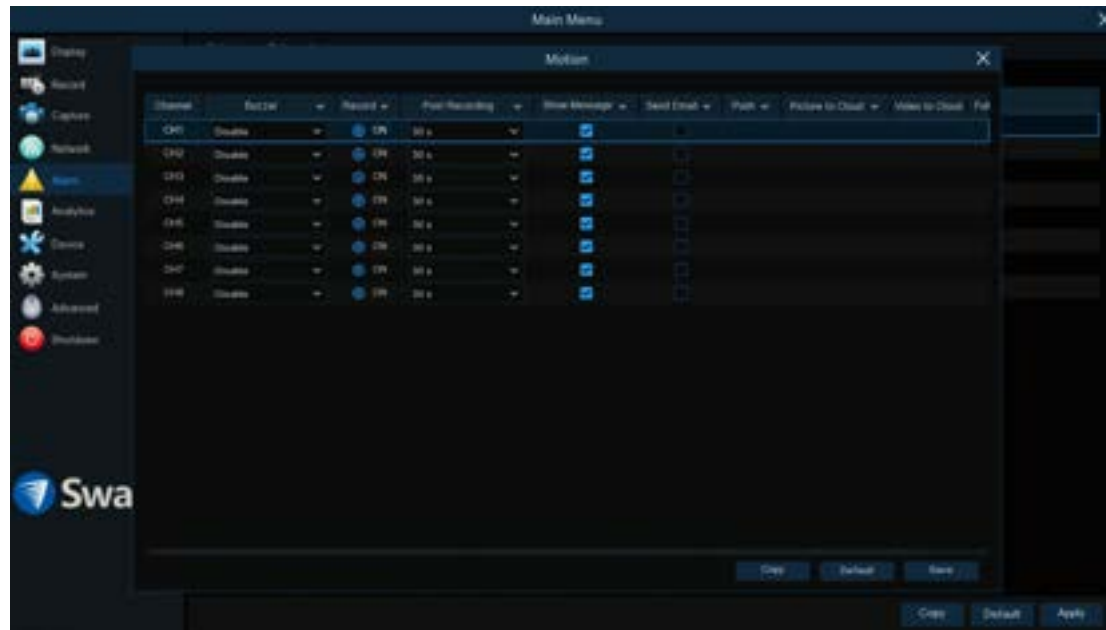

Buzzer: When motion has been detected, you can enable the DVR's buzzer to alert you for a predetermined amount of time. Click the drop down menu to select a time.

Record (Record Channel & Analog Channels): This option instructs your DVR to trigger additional cameras to start recording when motion has been detected. Click the "Analog Channels" checkbox to select all cameras or click on the individual camera number that you want to trigger for recording.

Post Recording: This option instructs your DVR to record for a set period of time after an event has occurred. For most instances, the default selection will be suitable, however you can change this if you wish.

Show Message: When motion has been detected, the motion icon will appear on-screen. Click the checkbox if you want to disable this.

Send Email: Click the checkbox to enable your DVR to send an email alert when motion has been detected.

Full Screen (slide to the right to view): Click the checkbox to view the camera full-screen in Live View mode when motion has been detected.

Click the "Save" button then click "OK". Right-click the mouse to exit.

Motion Detection Setup



1. Click “Clear All” to delete the default motion detection area.
2. To create a new motion detection area, press and hold the left mouse button to select the cell or square that you want to start at, then click and drag to select the area that you want to create. Release the mouse to finish.
3. Multiple areas can be created. Each individual cell or square can be enabled to detect motion. The same action also applies to delete an area that has been created.

In the example provided, a motion detection area has been created for the front yard but excludes objects such as trees as well as cars and pedestrians adjacent to the front yard of the house. Anyone who walks along the path via the front entrance and approaches the front door will be detected.

Movement outside of the motion detection areas will not be detected so will not trigger recordings or event notifications.

4. Adjust the sensitivity if required then right-click the mouse to exit.
5. Click “Apply” to save changes made.

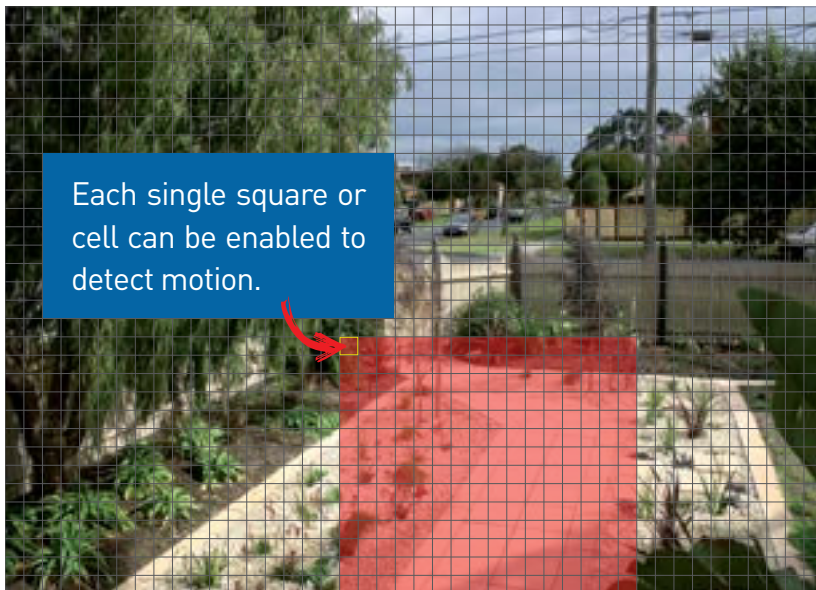

Motion Detection Tips

Placement of the cameras

1. Place cameras so they are facing areas where people have to walk through to approach your home regardless of where they are headed. A good idea is to place a camera overlooking your front door to capture an image of anyone approaching it for later reference. This is great if you have parcels delivered to your door or if the potential burglar knocks or rings the doorbell to see if anyone is home.
2. Walk around your house and assess where intruders are most likely to approach to enter, and what path they would take. Most burglars enter the home through a front or back door, so it's advisable to place the cameras near those areas so that you get the best amount of detail of anyone who approaches.
3. When installing cameras outside, it's important to keep your front and backyard as well-lit as possible for ideal night vision and the ability to detect motion. It's common for intruders to enter a home through an unlocked garage or by using a garage door opener in an unlocked car located in the driveway. Positioning your cameras to overlook cars in the driveway and similar locations can be very useful.

Avoiding False Triggers

1. A tree, shrub or foliage that is blown by the wind - angle the camera so wind-blown objects are out of the camera's view or use the camera motion detection area settings to exclude these areas from detection.
2. People moving along sidewalks or streets that are close to your home, aim your cameras and use the motion detection area settings to ensure only legitimate threats are triggering events.
3. Vehicles moving in the background - angle the camera so as to avoid movement in the background or use the motion detection area settings to stop detection of cars in the street.
4. Movement or light reflected off smooth surfaces such as glass - adjust the sensitivity level and/or avoid pointing the camera directly at glass surfaces.

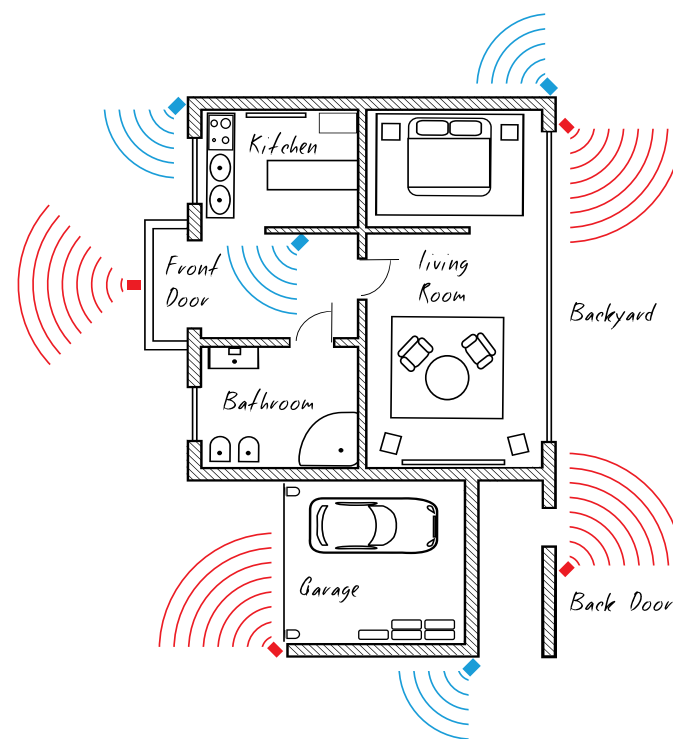

The **red cameras** illustrated (see above) are your primary locations. Place your cameras close to the front door, back door, garage entrance and overlooking the backyard.

The **blue cameras** illustrated are your secondary locations. If your DVR includes additional cameras, place these at the front entrance inside the home, the front of the house (this could overlook the front garden or driveway), a side gate or if you have multiple entrances to the backyard.

Thermal-Sensing Camera Tips

If thermal-sensing cameras have been included with your DVR or you have purchased them separately, the following tips will help you in getting the best results from your security system.

Your cameras have a built-in PIR (passive infrared motion detector) sensor. This means they can sense movement of warm objects including people, cars and animals. The advantage over cameras that don't have a PIR sensor, is they are very resistant to false triggers from changes in the image.

- PIR sensors work best when an intruder walks parallel or is passing across their "field of view" as opposed to walking directly at them. For example, in a hallway or path around the house you tend to walk parallel to the walls, not directly toward them. Position your cameras so that anyone approaching your home will cross the camera's view and trigger an event.
- For a recording to occur, the PIR must sense a warm object moving in front of it and the camera's image sensor must detect movement in the image. If either of these triggers has not occurred, no video will be recorded.
- When the PIR is triggered, the PIR icon (red box) will flash on-screen. If PIR and motion are triggered, the "running man" icon will be shown on-screen indicating that an event has occurred and that a recording is happening.
- The PIR can detect objects outside of the camera's field of view, so not everything that triggers the sensor will be visible on your camera.
- The PIR can reliably detect movement up to 30ft/9m, movement beyond this range may or may not be detected.
- Be aware that sudden changes in temperature of paths, roads, for example, can cause some minor false alerts to occur when there is also movement in the image such as trees and shadows.
- If some false triggering is occurring, use the motion area setup to remove moving objects from being detected, and to further refine your alerts (see page 31 - [Motion Detection Setup](#)).
- When used indoors, keep the cameras away from heating vents, heaters and other heat sources as they can trigger the PIR. However if there is no movement in the image, a false alert is unlikely.

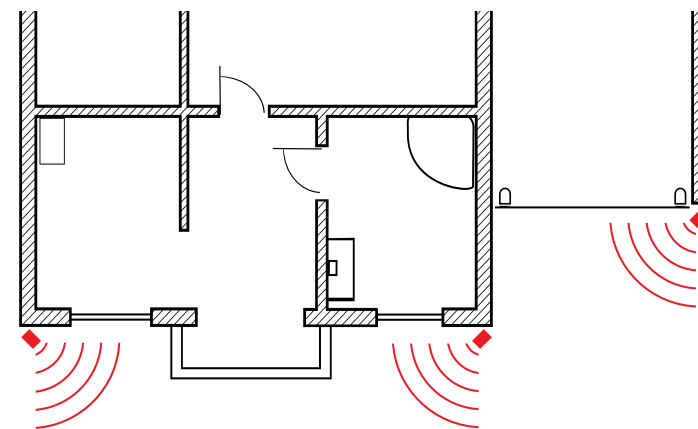

When installing cameras outside, mount them where intruders are most likely to enter (front & back doors, garage entrance). Angle the cameras so the intruder walks parallel to the sensor.

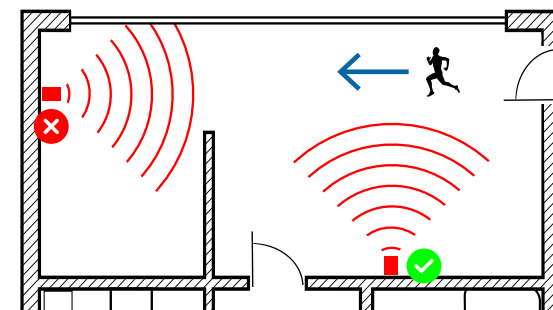

PIR sensors work best when an intruder walks parallel or is passing across their "field of view" as opposed to walking directly at them.

Alarm: Deterrent (Spotlight Compatible Cameras)

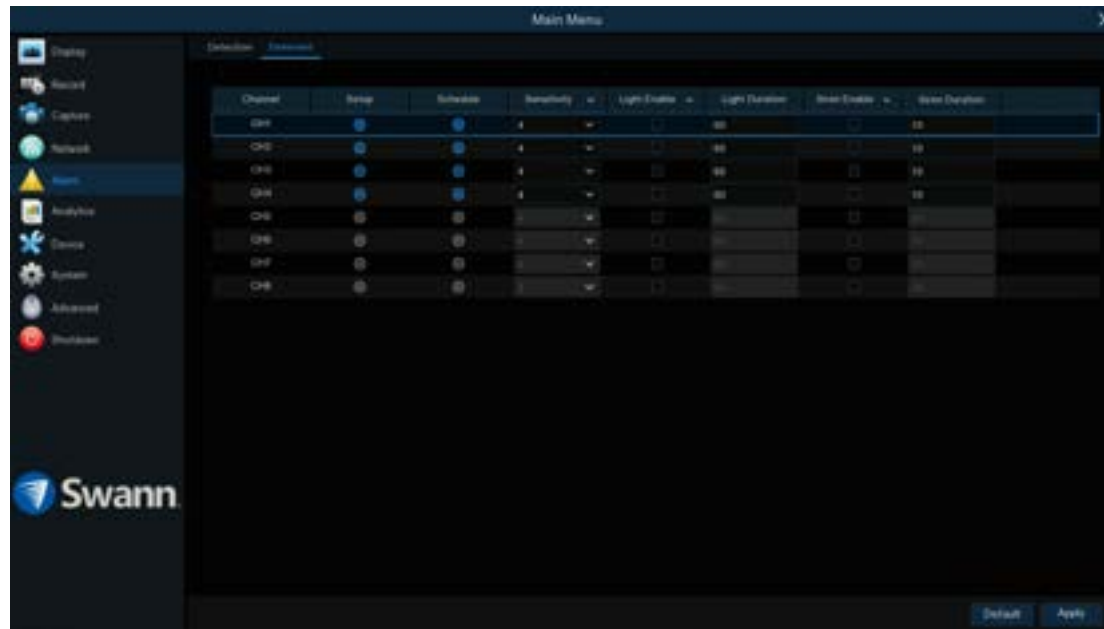

Each camera input on your DVR will be displayed as CH1, CH2, etc.

Setup: Click the button to change the default spotlight detection area. The entire view of the camera is enabled, however you can select certain areas if you wish (see page 35 - [Spotlight Detection Setup](#)).

Schedule: Click the button to change the default spotlight schedule (see page 36 - [Spotlight Trigger Schedule](#)).

Sensitivity: This option allows you to change how sensitive the spotlight will be when your DVR has detected motion. This is independent of the camera's sensitivity for detecting motion. As an example, you may want to record movement that is happening in the background but you don't want the spotlight and or the siren to be triggered until one or more objects gets closer to the camera. For this scenario, you would adjust the sensitivity to 1 or 2.

Light Enable: Click the checkbox to enable the camera's spotlight.

Light Duration: Lets you change the length of time the spotlight will remain lit when motion has been detected. Adjust accordingly.

Siren Enable: The camera's siren is disabled by default. If the siren is required, click the drop down menu to enable (this function is only available if your camera has a built-in siren). A warning message will appear on-screen. Click "OK" to continue.

Siren Duration: Lets you change the length of time the siren will remain turned on when motion has been detected. Adjust accordingly.

Spotlight Detection Setup



1. Click “Clear All” to delete the default spotlight detection area.
2. To create a new spotlight detection area, press and hold the left mouse button to select the cell or square that you want to start at, then click and drag to select the area that you want to create. Release the mouse to finish.
3. Multiple areas can be created. Each individual square can be enabled to trigger the spotlight. The same action also applies to delete an area that has been created.

In the example provided, a spotlight detection area has been created for the backyard and will trigger the spotlight when one or more objects gets closer to the rear of the house.

Movement outside of the spotlight detection area will not trigger the spotlight.

Light Enable: Click the drop down menu to enable the camera’s spotlight.

Siren Enable: Click the drop down menu to enable the camera’s siren. A warning message will appear on-screen. Click “OK” to continue.

Sensitivity: Click the drop down menu to adjust the sensitivity if needed.

4. Right-click the mouse to exit.

5. Click “Apply” to save changes made.

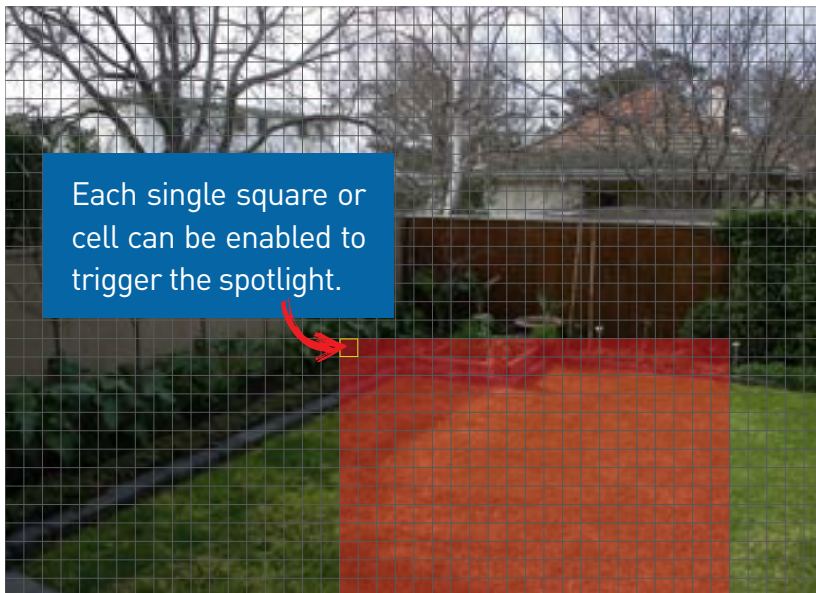

Spotlight Trigger Schedule

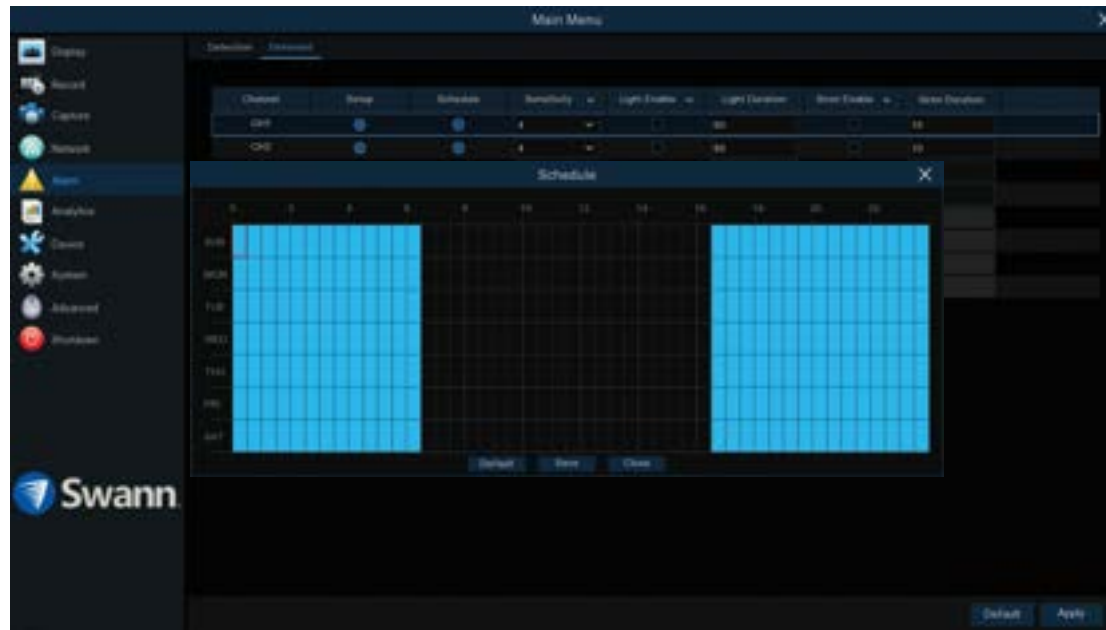

By default, the spotlight and siren will not trigger between 06:30 a.m. and 04:30 p.m., however you can change this according to your needs.

Each square represents 30 minutes. Using the mouse, click on a particular square to change or click and drag the mouse over the squares corresponding to your desired time period.

Click "Save" to save changes made. Right-click the mouse to exit.

Device: PTZ

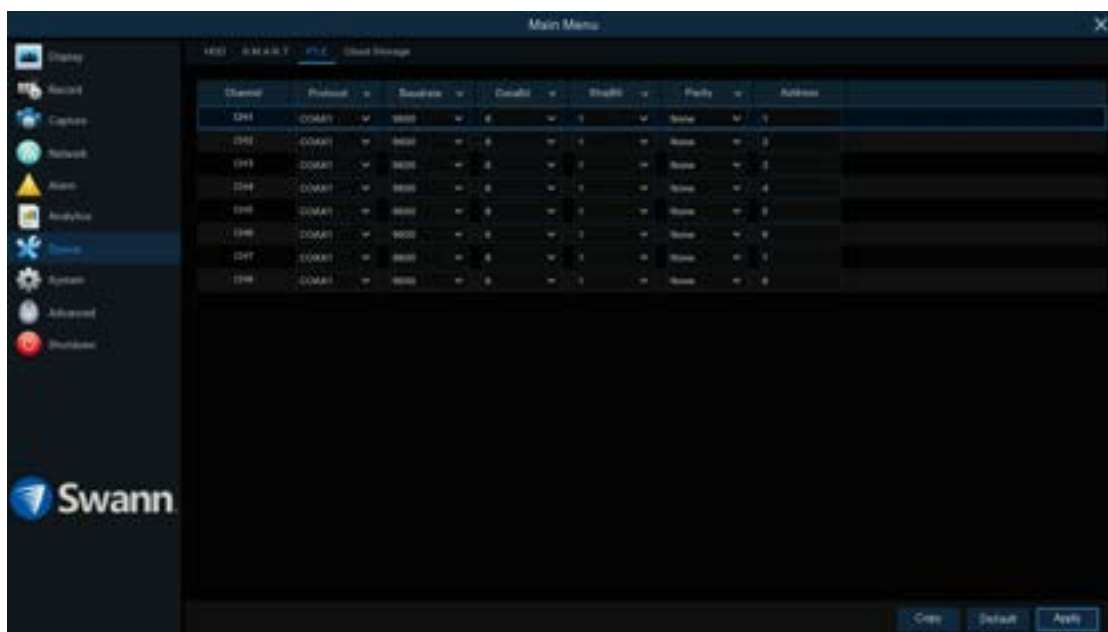

- Use the “Copy” function to apply all settings to the other cameras connected.
- Click “Default” to revert to default settings.
- Click “Apply” to save settings.

If you have a compatible PTZ camera connected to your DVR, you can use the PTZ controls to move the camera as well as the ability to zoom into an object and to control the level of focus (if available). You can create multiple preset positions, which can be recalled to focus the camera’s view to a different position. Cruise mode can also be used to move the camera to different preset positions that have been created.

To configure your PTZ camera, consult the instruction manual included with your device then match those settings here.

For instructions on how to control your PTZ camera and creating preset positions (see page 38 - [Controlling your PTZ Camera](#)).

Controlling your PTZ Camera



A Swann Pro-1080PTZ camera has been used in the example provided. This model is compatible with the 4580, 4980 & 5580 series of DVRs.

To control your PTZ camera, in Live View mode click on the channel the camera is connected to then click the “PTZ” button located on the camera toolbar. The channel will go semi full-screen. Click the “PTZ” tab to access the controls (as shown on the left).

1. If you have multiple PTZ cameras connected, click this to select a different camera.
2. Click this to access the camera’s on-screen display (see page 40 - [Camera’s On-screen Display](#)).
3. Click this to create a preset. A preset is a particular position within the image that you would like the camera to focus on (see page 39 - [Creating a Preset](#)).
4. Click the directional buttons to move the camera in the direction selected. Click the middle button to continually pan the camera left and right (click the left or right directional button to stop).
5. Adjust the speed control to alter how fast or slow the camera will pan or tilt. Move the slider to decrease or increase the speed.
6. This allows you to zoom into an object and out again. Click the “+” button to zoom in and click the “-” button to zoom out.
7. This allows you to control the camera’s level of focus. Depending on the object that your camera is focused on, if the object or overall picture appears blurry, click the “+” and “-” buttons to adjust the camera’s focus until the object or picture appears in focus.

Depending on the camera you have, the Iris control may not be available.

Creating a Preset



1. If you have multiple PTZ cameras connected, click this to select a different camera.
2. Click the directional buttons to move the camera in the direction selected.
3. Each preset position will have a different number assigned to it. To recall a particular position, click the dialogue box, input a number then click the “GO TO” button. The camera will then move to that particular position. When creating a preset position, you may want to make note which position is assigned to each number.
4. Click the dialogue box to change the length of time (in seconds) the camera will stay at a particular position, before moving to the next position.
5. Click this to create a preset.
6. Click this to delete a preset (when selected). Subsequent clicks will delete all presets created.

7. Click this to go to a particular preset position.

8. Click this to start cruise mode (preset positions must be created first). This mode instructs your DVR to automatically move the camera according to the preset positions that have been created. Click again to stop cruise mode.

9. Click this to save any changes made.

Creating a Preset

- To create a preset, use the PTZ controls to move the camera to the desired focal position. Click “PTZ” to access the zoom and focus controls. Use the speed control to alter how fast or slow the camera will move.
- Change the length of time the camera will stay at this position.
- Click the “+” button to create the preset. You will notice that the preset position will increase each time a preset is created. The total number of presets created will also be displayed. Up to 255 different preset positions can be created.
- Repeat these steps to create multiple preset positions. When finished, click the “Save” button to save. Right-click to exit.
- Click the “Start Cruise” button to continually cycle through each preset created. Click again to stop.



Please note: Before using cruise mode, you need to reboot your DVR and the camera after creating one or more presets.

TIP

Camera's On-Screen Display (OSD)

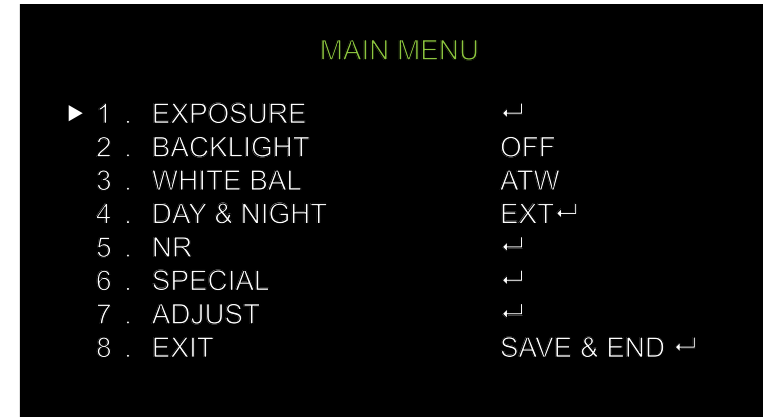
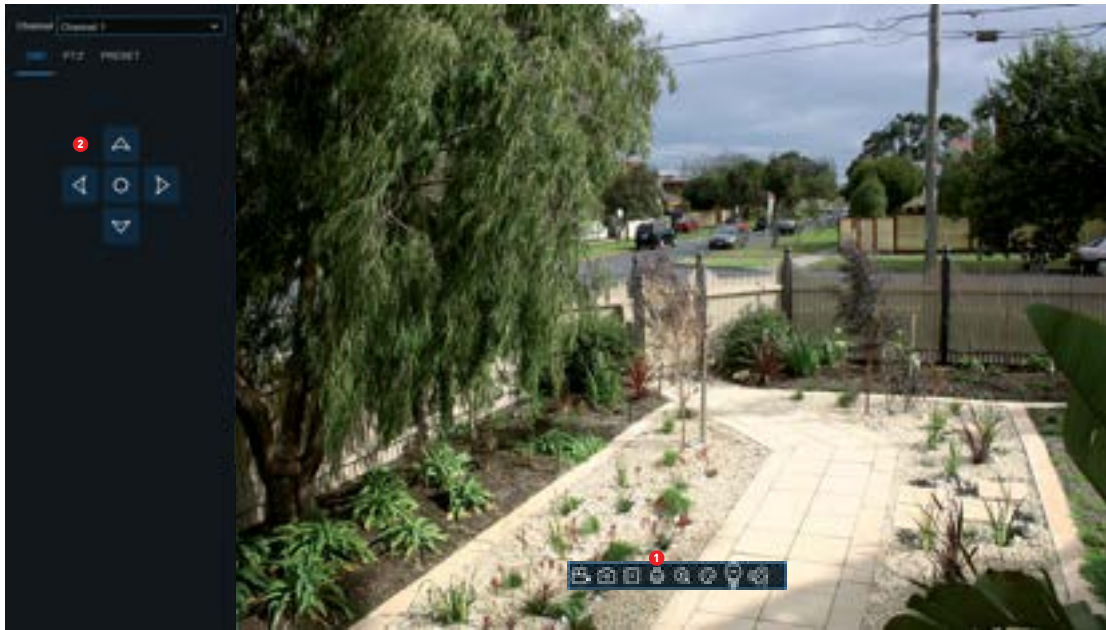

When accessing the camera's OSD, the Main Menu will appear first. From here you can access the settings available. Use the controls to navigate.

1. To access the camera's OSD, in Live View mode, click the camera then click the "PTZ" button on the Camera Toolbar.

2. The channel will go semi full-screen and the navigation controls will appear on the left. Click the middle button (circle) to display the Main Menu. Click the up and down arrow buttons to navigate. Click the left and right arrow buttons to change settings. Click the middle button to enter sub-menus and to confirm changes.

Right-click the mouse to exit.

OSD: 4K Series - Main Menu

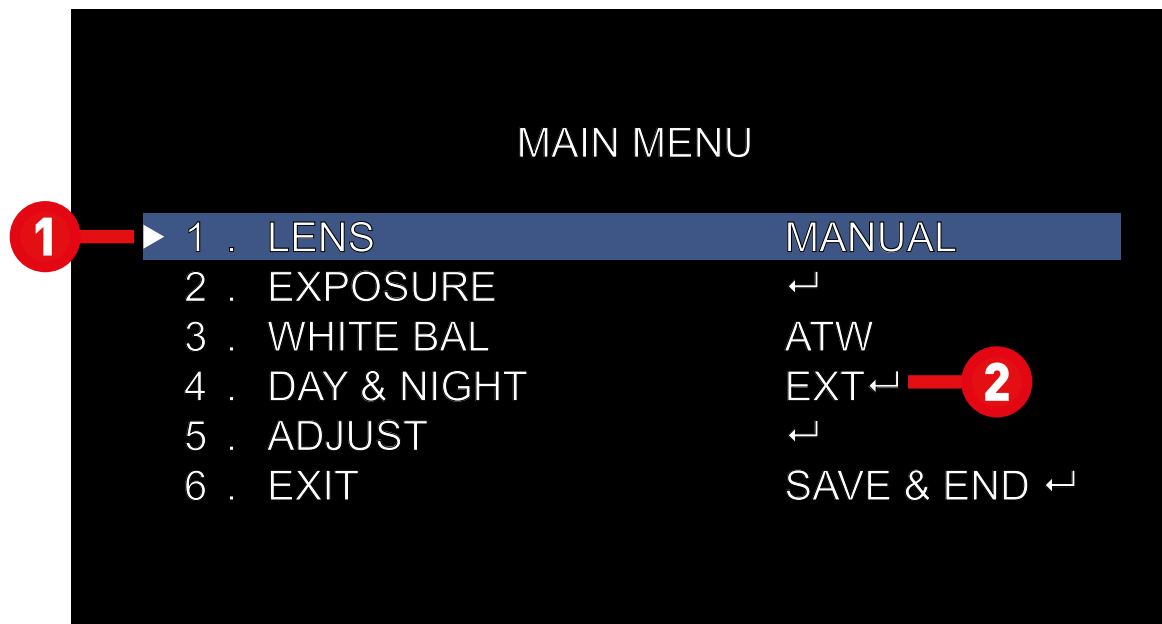

When accessing the OSD, the Main Menu will appear first. From here you can access the various settings available.

1. Indicates the option or setting selected.

2. Indicates a sub-menu is accessible.

Lens: This is a common setting that is available within different OSDs. For this particular model, the setting cannot be changed.

Exposure: This setting determines how light or dark the image will appear.

White Bal (Balance): This setting controls the white balance so that objects that appear white in person are rendered white within the image. This also takes into account the color temperature of a light source, which refers to the relative warmth or coolness of white light.

Day & Night: Choose how the camera manages the transition from day to night and back again.

Adjust: Gives you access to settings such as sharpness, color gain and display language.

Exit: If any of the settings are changed, select SAVE & END. To exit without saving, select NOT SAVE. To reset the camera back to default settings, select RESET.

OSD: 4K Series - Exposure

EXPOSURE	
▶ 1 . SHUTTER	AUTO
2 . AGC	15
3 . BRIGHTNESS	40
4 . D-WDR	OFF
5 . BACKLIGHT	OFF
6 . RETURN	RET ↵

Shutter: In most circumstances the default setting should be suitable, however if the picture is flickering, change this to FLK (flicker-less mode).

AGC (Automatic Gain Control): This allows an increase in sensitivity, enabling operation in lower light conditions. Use the left and right buttons to decrease or increase the gain level. Just be aware that increasing the gain too high will also increase the video noise visible.

Brightness: This changes how light the image appears to be. Use the left and right buttons to decrease or increase the brightness level.

D-WDR (Wide Dynamic Range): This will balance out images that have a large dynamic range. An example of this would be if an indoor camera is pointing towards a window or building entrance. The image produced by the camera during the day would be extremely washed out due to the high

brightness of the incoming light. If the camera is mounted in a location where this is required, change this to AUTO.

Backlight: Improves exposure of an object that is in front of a light source. This may happen if an object is in front of a window. The camera will pickup the natural light, therefore the object or person in the foreground becomes dark. If the camera is mounted in a location where this is required, change this to BLC (back light compensation). Click the middle button to enter the sub-menu (for further instructions [click here](#)).

Return: Select this to go back to the previous menu. If any of the settings are changed, select SAVE & END.

OSD: 4K Series - Exposure: BLC

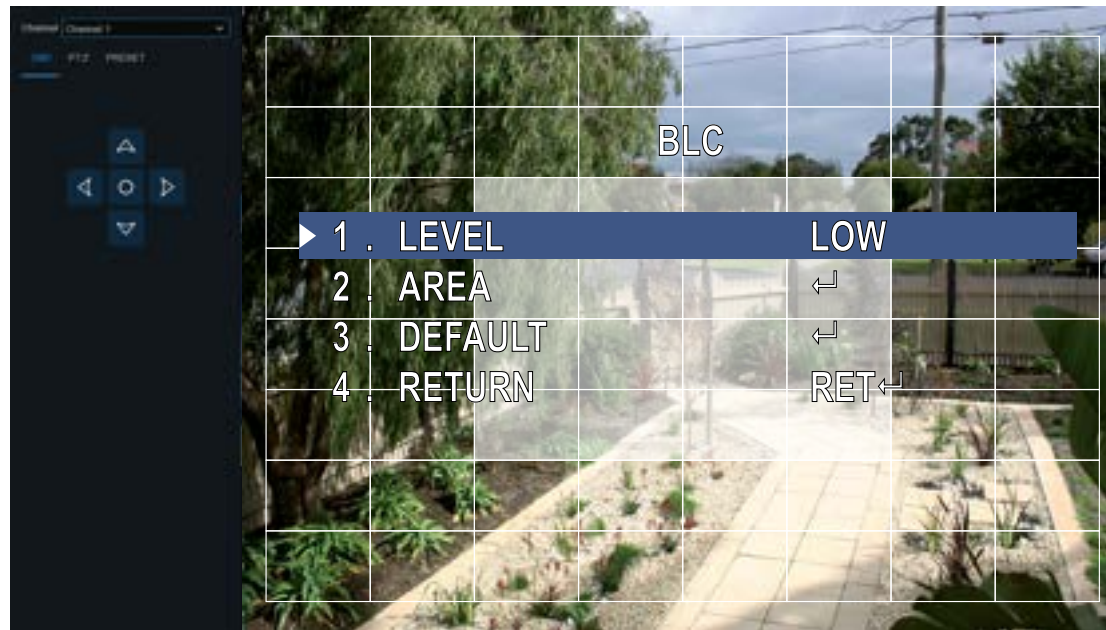

Level: Select the level of back light compensation that you would like to apply. Some experimentation is recommended to select the best setting.

Area: This function allows you to reposition and or resize the BLC region. You will see a 8x8 grid with the shaded area representing the BLC region. Click the middle button to change (for instructions [click here](#)).

Default: This will reset any settings changed.

Return: Select this to go back to the previous menu. If any of the settings are changed, select SAVE & END.

OSD: 4K Series - Exposure: BLC - Area

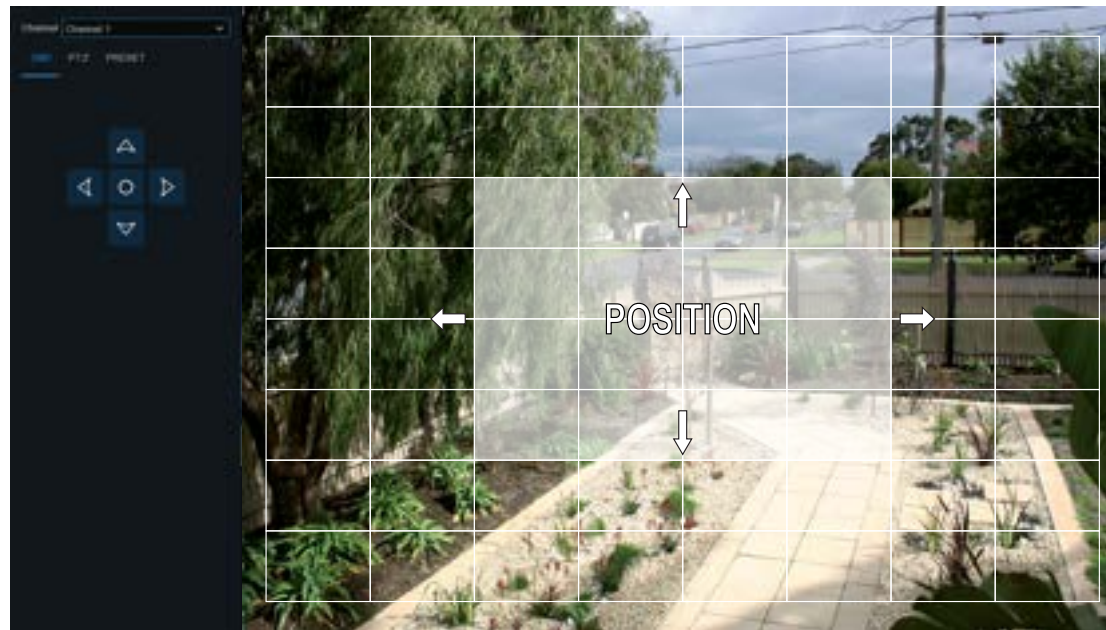

Position: Use the directional buttons to move the camera's BLC region along the grid displayed (you will see the word POSITION). When finished, click the middle button.

Size: Use the directional buttons to resize the camera's BLC region along the grid displayed (you will see the word SIZE). When finished, click the middle button.

Some experimentation is required to get the correct position and size required. Click the middle button again to exit.

OSD: 4K Series - White Bal (Balance)

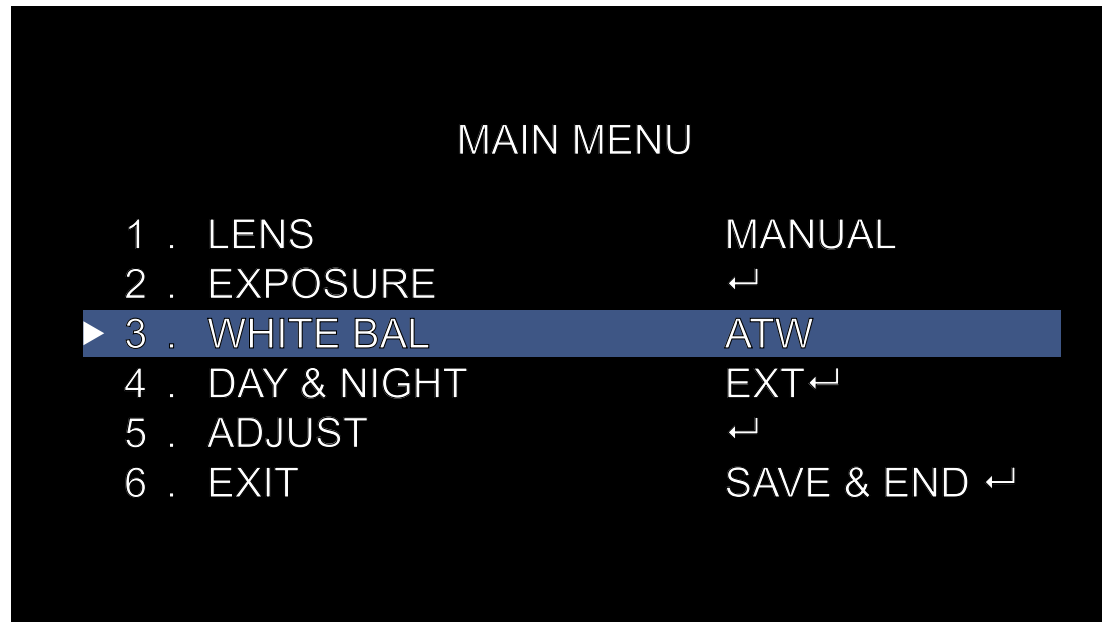

By default, the camera's white balance is set to ATW (auto tracking white balance) to detect when the ambient light shifts significantly and changes the white balance automatically.

There is an additional option that you can select. You can change this to AWC (auto white balance control). This is suitable for a location where the light source is stable. Click the left or right button to change. To set the AWC, hold a white card or paper in front of the camera then click the middle button. The camera will register that color as "white" and will adjust the white balance accordingly.

OSD: 4K Series - Day & Night: Ext

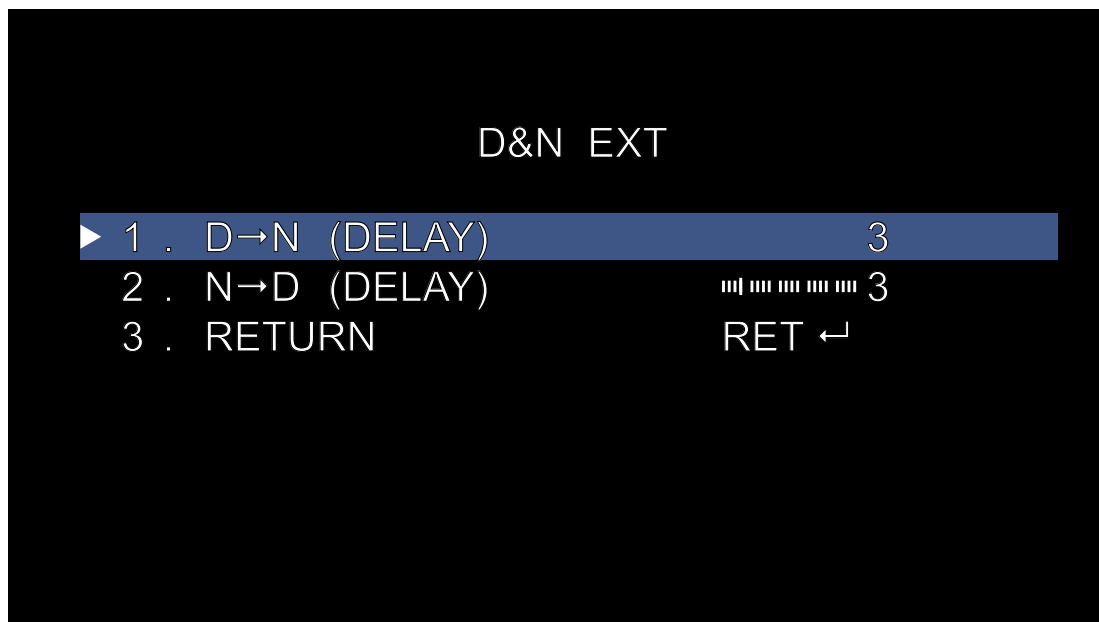

The EXT setting enables the camera to switch between day and night using the camera's external sensor. Click the middle button to change settings (the time is in seconds).

D→N (Delay): Controls the delay of the external sensor when transitioning from day to night. Use the left and right buttons to change. The higher the number, the greater the delay.

N→D (Delay): Same as above but the transition is from night to day.

Return: Select this to go back to the previous menu. If any of the settings are changed, select SAVE & END.

OSD: 4K Series - Day & Night: Auto

D&N AUTO		
▶ 1 .	D→N (CDS)	10
2 .	D→N (DELAY)	3
3 .	N→D (CDS)	0
4 .	N→D (DELAY)	3
5 .	RETURN	RET ↵

For this particular model (PRO-4KMSFB), the AUTO setting is not supported.

OSD: 4K Series - Day & Night: Color

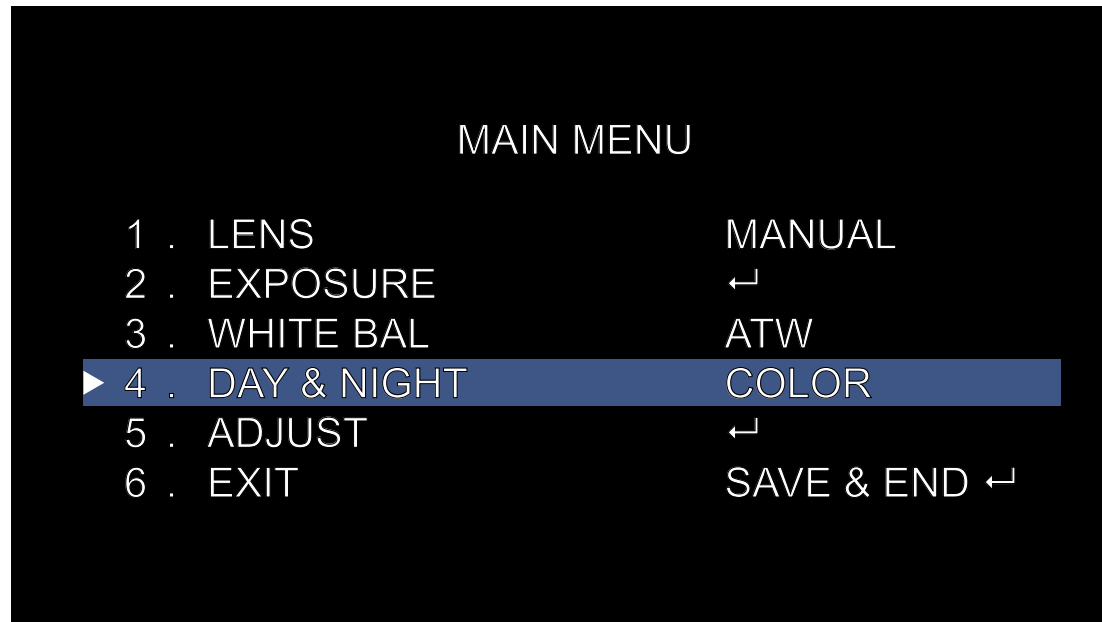

This will instruct the camera to operate in color mode only. In low-light conditions, the color will be quite faint. Image clarity will also be reduced in low-light conditions.

OSD: 4K Series - Day & Night: B/W (Black & White)

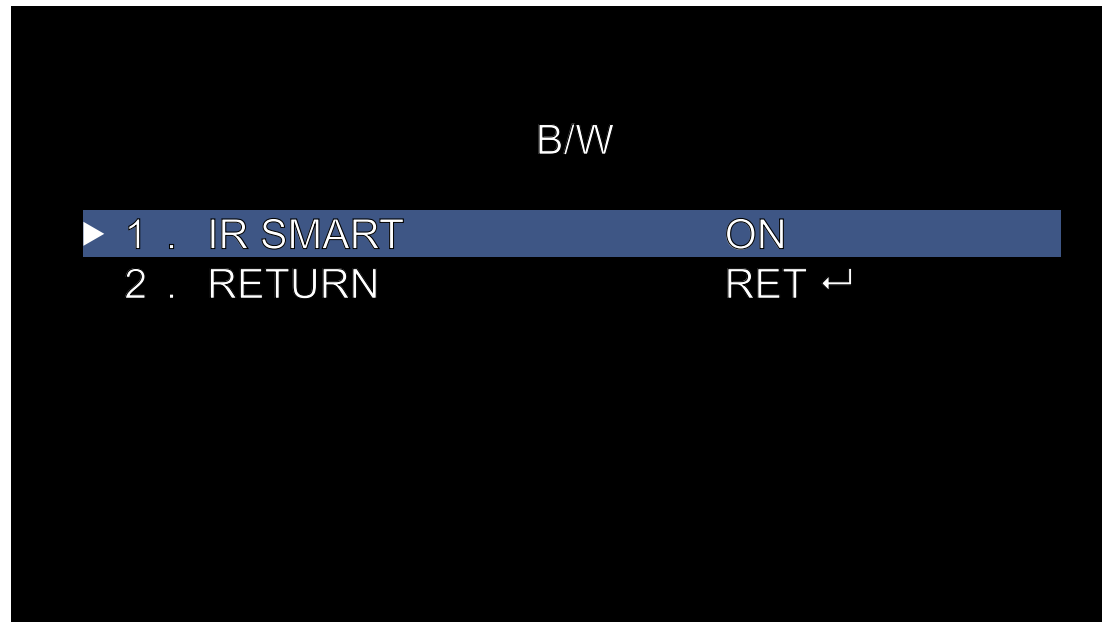

The B/W setting will instruct the camera to operate in black & white mode only. Click the middle button to change settings (as shown above).

IR Smart: By default, the camera will adjust the intensity of its infrared LEDs to compensate for the distance of an object so that the infrared does not over-expose the object. It's recommended to leave this enabled.

Return: Select this to go back to the previous menu. If any of the settings are changed, select SAVE & END.

OSD: 4K Series - Adjust

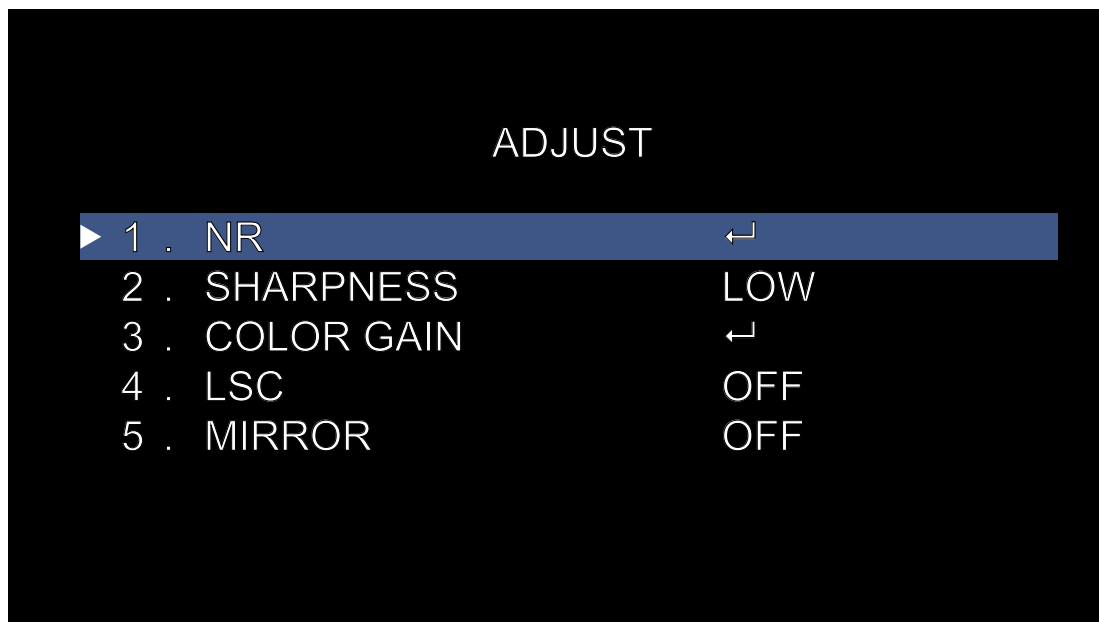

NR (Noise Reduction): Aims to reduce the amount of noise or static in the image, resulting from the amplification of the signal. Noise is commonly seen in low-light conditions. Click the middle button to enter the sub-menu (for further instructions [click here](#)).

Sharpness: The clarity of detail and edges in the image. You can select LOW, MIDDLE or HIGH. Setting the sharpness high may make the image and especially edges look pixelated. Setting the sharpness low may result in a soft image. Select the best setting for the camera's location.

Color Gain: The amount of color amplification in the image. Higher values will make the color appear more vivid, but can result in color bleed. Click the middle button to enter the sub-menu (for further instructions [click here](#)).

LSC (Lens Shading Correction): If the periphery or outer image of the cam-

era is darkened or blurred, enable this setting.

Mirror: Depending on how the camera is mounted, this will change the camera's orientation. There are three orientations available.

(continued on next page)

OSD: 4K Series - Adjust

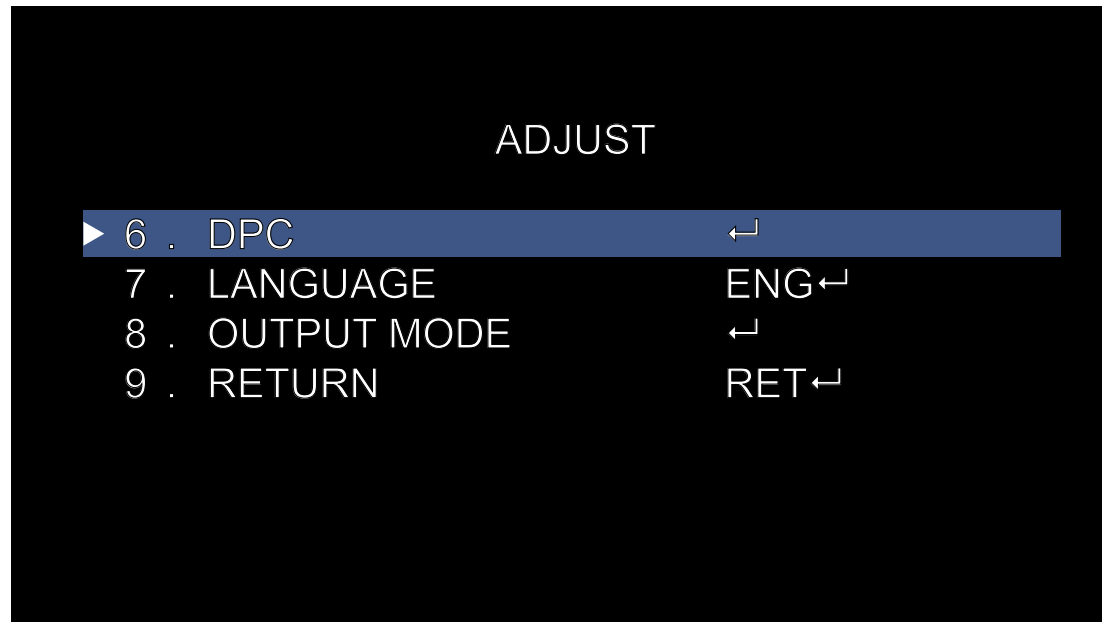

DPC (Dead Pixel Correction): Sometimes video sensors can develop a dead pixel. This does not disable the camera but may make the image a little annoying to look at. This setting will find any dead pixels and mark them digitally. It's recommended to leave this enabled.

Language: Indicates the language used for the OSD. Several languages are available.

Output Mode: Select the correct video standard for your country. USA, Canada and Japan are NTSC. UK, Australia and New Zealand are PAL.

Return: Select this to go back to the previous menu. If any of the settings are changed, select SAVE & END.

OSD: 4K Series - Adjust: NR (Noise Reduction)



2DNR: 2D noise reduction analyzes individual frames of video, using a special algorithm filter to mitigate the effects of noise. Select the best setting for the camera's location.

3DNR: 3D noise reduction analyzes frames in sequence to differentiate pixels that likely represent noise. This is especially useful for recordings done at night or in lower light conditions. Select the best setting for the camera's location.

Return: Select this to go back to the previous menu. If any of the settings are changed, select SAVE & END.

OSD: 4K Series - Adjust: Color Gain

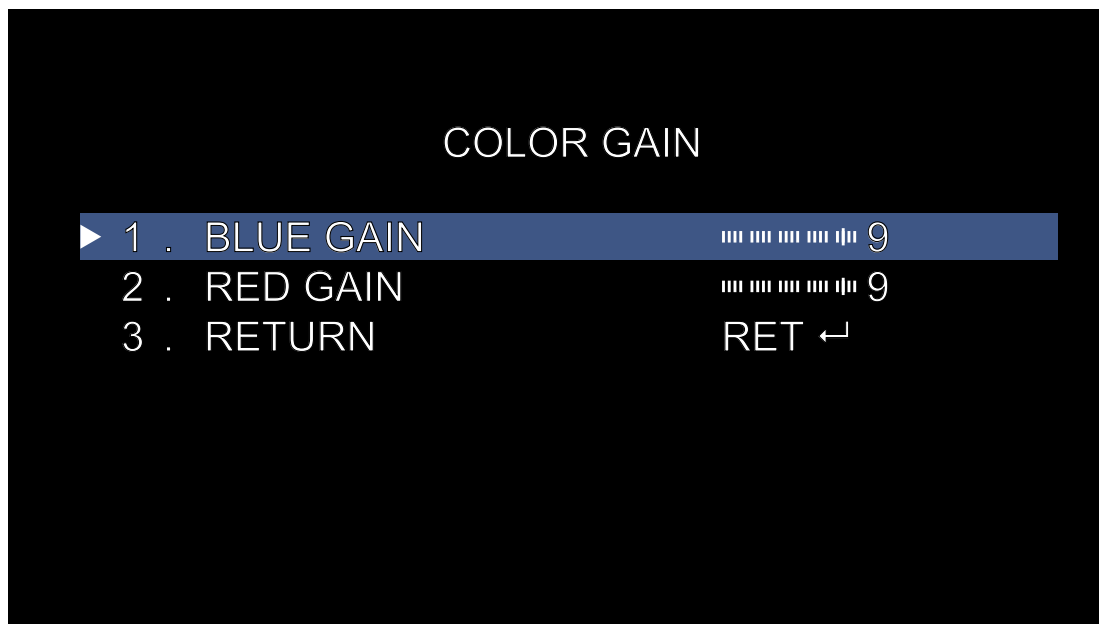

Blue Gain: If you think the color in the image has too much blue or too little blue, use the left and right buttons to change.

Red Gain: If you think the color in the image has too much red or too little red, use the left and right buttons to change.

Return: Select this to go back to the previous menu. If any of the settings are changed, select SAVE & END.

OSD: 4K Series - Hidden

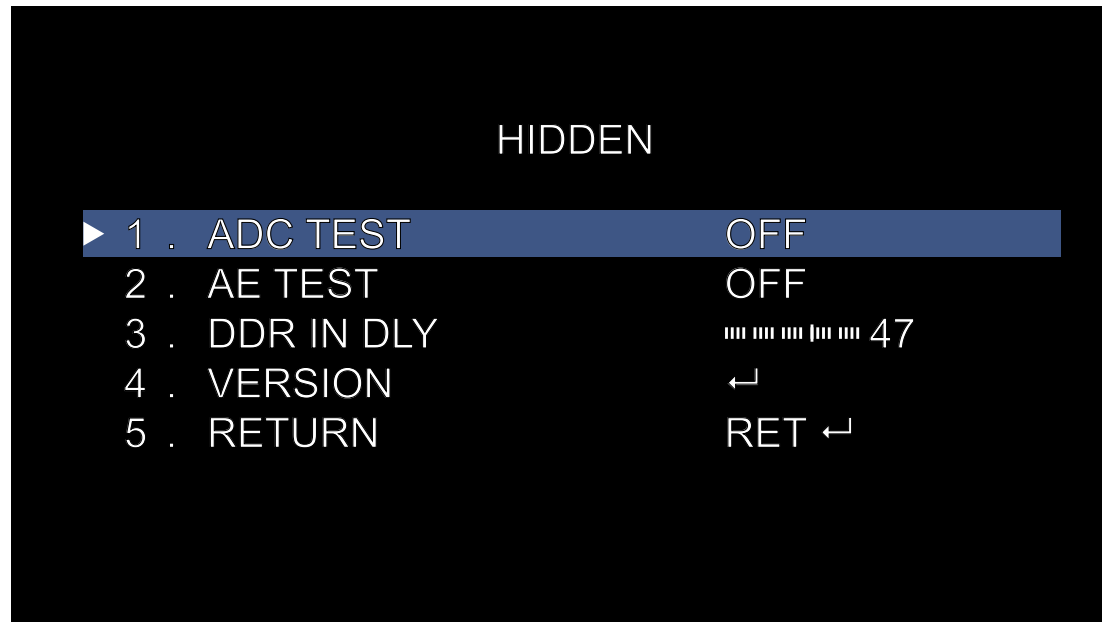

To access the Hidden menu, at the Main Menu select EXPOSURE, click the right button three times then click the middle button to enter.

In most circumstances, the information here is not needed for general use of the camera, however one of our Swann Helpdesk & Technical Support staff may ask you to access this if you call for assistance.

OSD: 3K Series - Main Menu

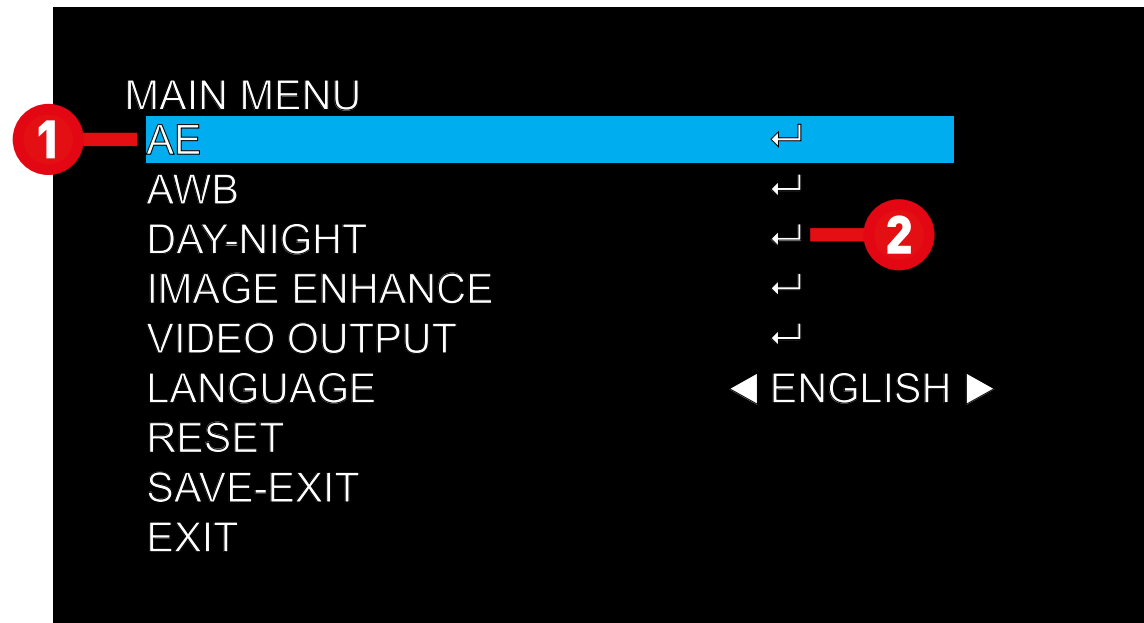

When accessing the OSD, the Main Menu will appear first. From here you can access the various settings available.

1. Indicates the option or setting selected.

2. Indicates a sub-menu is accessible.

AE (Automatic Exposure): This setting allows you to adjust controls relating to exposure.

AWB (Automatic White Balance): This setting controls the white balance so that objects that appear white in person are rendered white within the image.

Day-Night: Choose how the camera manages the transition from day to night and back again.

Image Enhance: Lets you manually adjust the levels of sharpness, contrast

and saturation in the displayed image.

Video Output: The settings here cannot be changed.

Language: Sets the language for the OSD menus.

Reset: Force the camera back to default settings (does not reset the language option).

Save-Exit: Save any changes made and exit the menu.

Exit: Exit the menu without saving changes. Any unsaved changes will be lost when the camera is powered off.

OSD: 3K Series - AE (Auto Exposure)

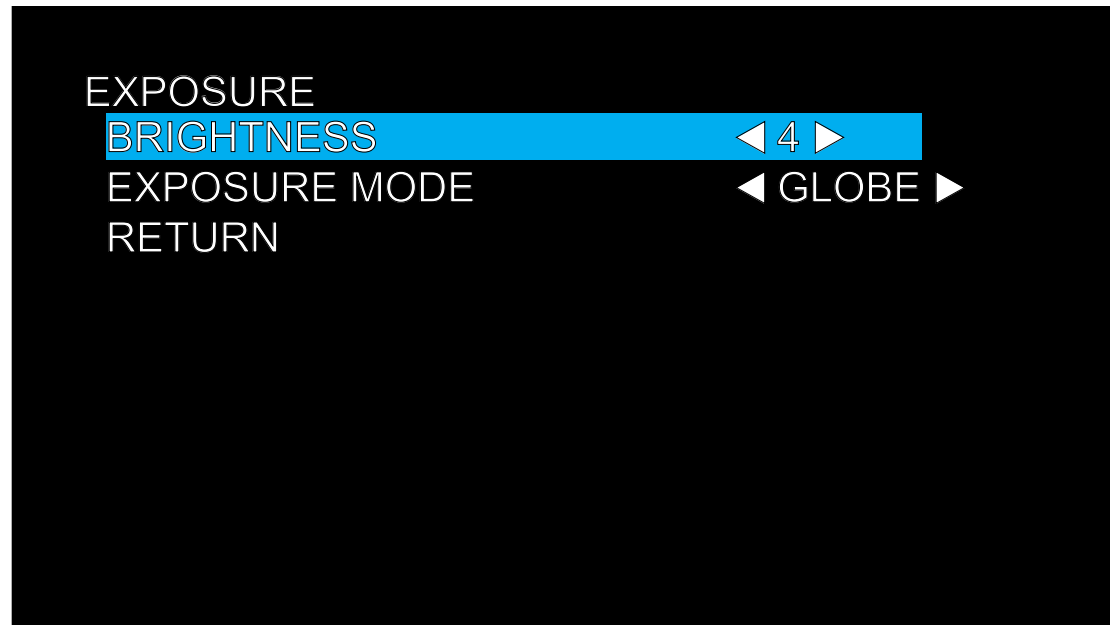

Brightness: This adjusts the direct gain of the image, making the whole scene look whiter or brighter. Adjust accordingly.

Exposure Mode (Globe, BLC): This sets the exposure time to account for the amount of light present and how long the sensor should collect light before producing an image. The default setting (Globe) selects automatic exposure settings. The BLC setting allows manual adjustment in a particular range. This is helpful for situations where there is light in front of the camera that is placing the subject area in shadow.

Return: Select this to go back to the Main Menu.

OSD: 3K Series - AWB (Automatic White Balance)

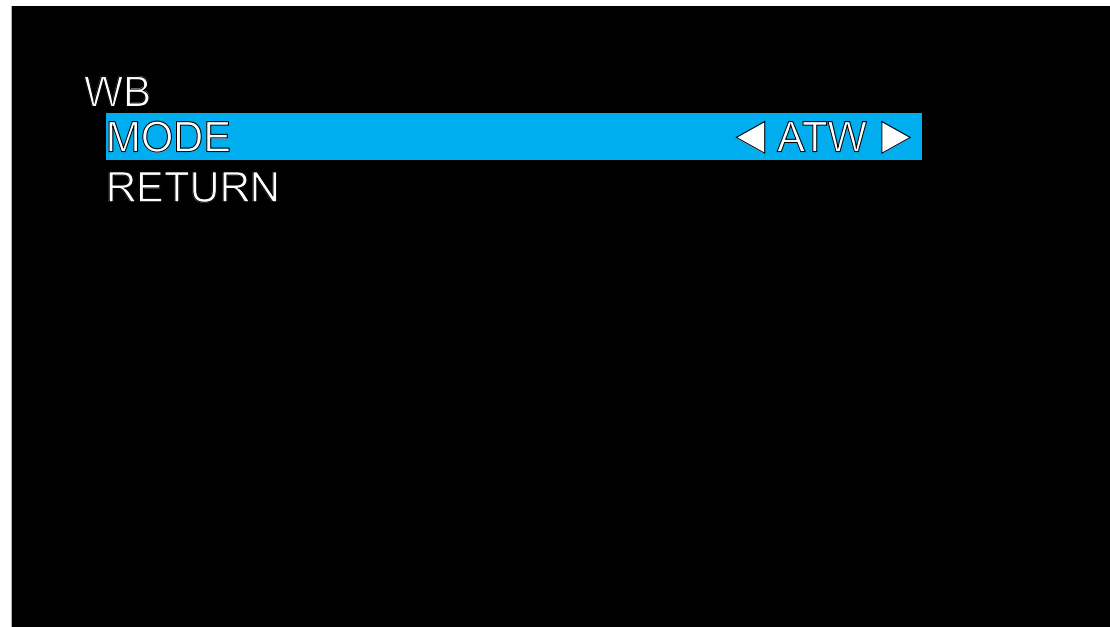

ATW (Automatic White Balance): The camera automatically sets the White Balance according to the light it receives. We recommend using this setting for most circumstances.

MWB (Manual White Balance): This setting will set the White Balance manually. You can select the gain (amplification) of the red and blue channel (RGAIN & BGAIN) to adjust the color of the image.

Return: Select this to go back to the Main Menu.

OSD: 3K Series - Day-Night

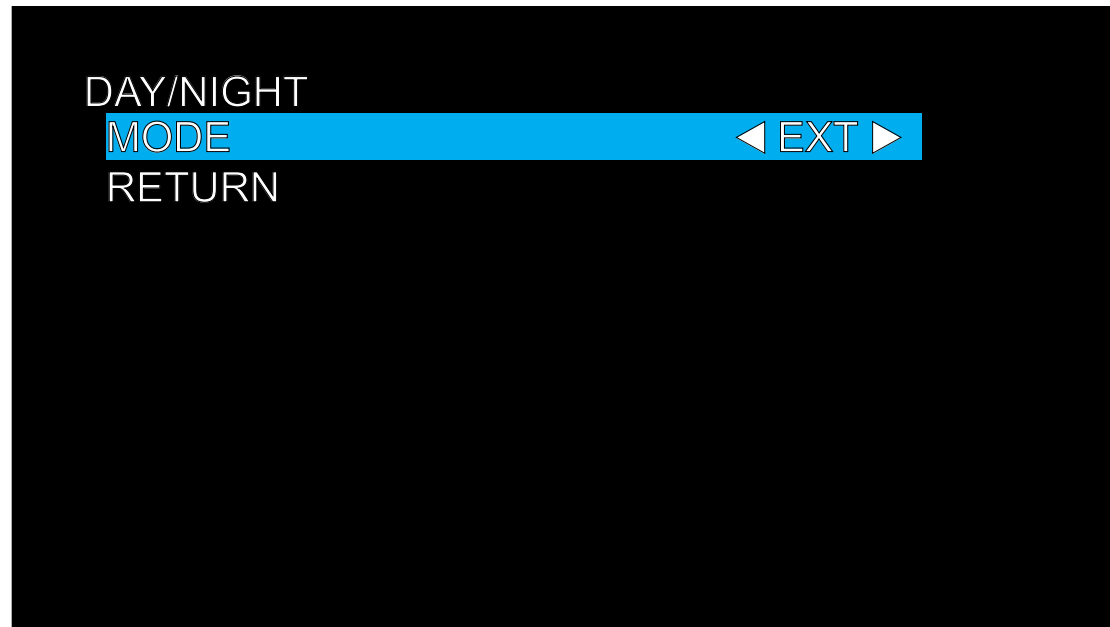

EXT & Auto: The camera determines when to switch from day to night and back to day. Auto is the best option as this will display color during the day and black & white at night.

Color: The camera will operate in color mode only. In low-light conditions, the color will be faint. Only visible light will be detected.

B/W: The camera will operate in night mode only and the image will be in black & white during the day.

Return: Select this to go back to the Main Menu.

OSD: 3K Series - Image Enhance

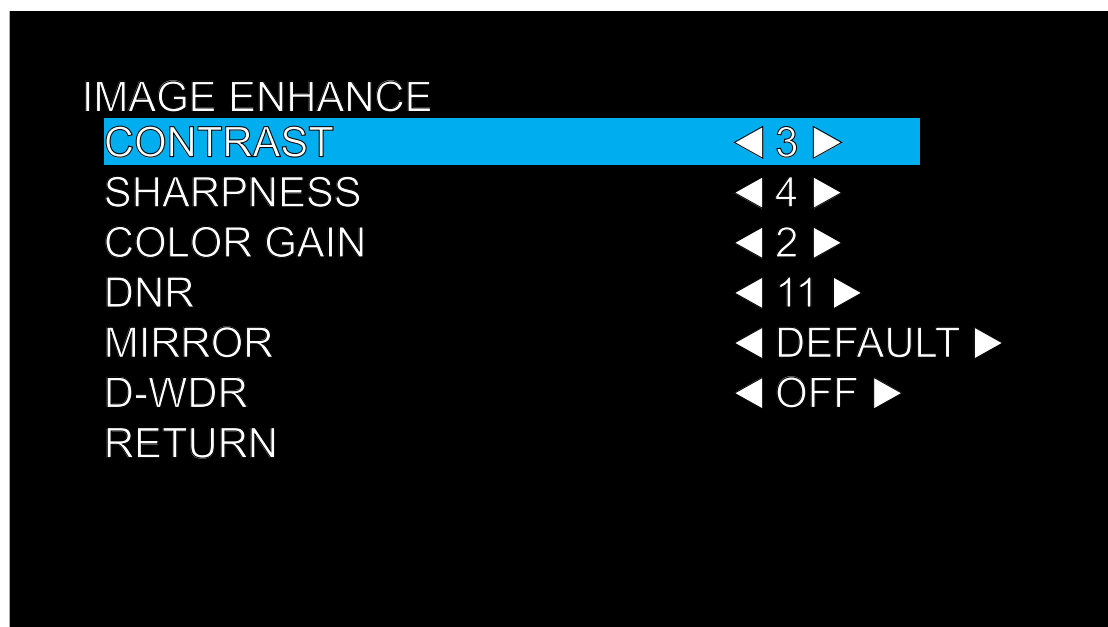

Contrast: This affects the color difference of the camera. A lower setting will make the image more gray and blended, while a higher setting will make the light and dark areas of the image more pronounced.

Sharpness: This affects the clarity of detail and edges in the image. Setting the sharpness too high will make the image and especially edges look pixelated. Setting it too low will result in a soft and slightly blurry image.

Color Gain: More commonly known as saturation, the amount of color amplification in the image. Higher values will make the color more vivid, but can result in color bleed (where the color is projected outward slightly from the edges of an object). Set a value that makes the colors look right.

DNR (Digital Noise Reduction): This aims to reduce the amount of noise (static) in the image resulting from the amplification of the signal. Noise is

most commonly seen in low-light conditions. Setting this value too high can result in reduced clarity of the image when objects are moving relatively quickly through the scene.

Mirror: Lets you horizontally and vertically reverse the orientation of the image. This is useful if mounting the camera upside down or on a vertical surface.

D-WDR (Digital Wide Dynamic Range): This causes the camera to take multiple exposures and average out the result. This will reduce the impact of different light levels in the image, causing dark areas to be brighter and reducing the flaring of exceptionally bright areas. This setting may increase the amount of noise (static) in the image.

Return: Select this to go back to the Main Menu.

OSD: 4K Ready – Main Menu

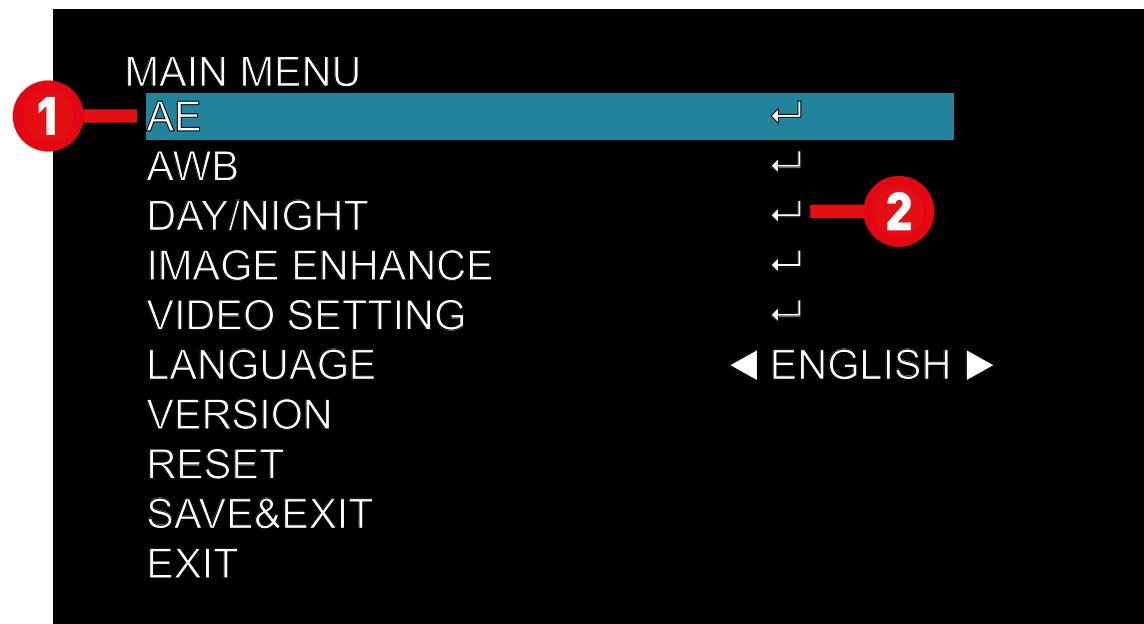

When accessing the OSD, the Main Menu will appear first. From here you can access the various settings available.

1. Indicates the option or setting selected.

2. Indicates a sub-menu is accessible.

AE (Automatic Exposure): This setting allows you to adjust controls relating to exposure.

AWB (Automatic White Balance): This setting controls the white balance so that objects that appear white in person are rendered white within the image.

Day/Night: Choose how the camera manages the transition from day to night and back again.

Image Enhance: Lets you manually adjust the levels of sharpness, contrast

and saturation in the displayed image.

Video Setting: The settings here cannot be changed.

Language: Sets the language for the OSD menus.

Version: Displays the camera's firmware version.

Reset: Force the camera back to default settings (does not reset the language option).

Save&Exit: Save any changes made and exit the menu.

Exit: Exit the menu without saving changes. Any unsaved changes will be lost when the camera is powered off.

OSD: 4K Ready - AE (Auto Exposure)



Brightness: This adjusts the direct gain of the image, making the whole scene look whiter or brighter. Adjust accordingly.

Exposure Mode (Global, BLC): This sets the exposure time to account for the amount of light present and how long the sensor should collect light before producing an image. The default setting (Global) selects automatic exposure settings. The BLC setting allows manual adjustment in a particular range. This is helpful for situations where there is light in front of the camera that is placing the subject area in shadow.

Return: Select this to go back to the Main Menu.

OSD: 4K Ready - AWB (Automatic White Balance)



Mode: This setting has no function with this model camera.

RGAIN: If you think the color in the image has too much red or too little red, use the left and right buttons to change.

BGAIN: If you think the color in the image has too much blue or too little blue, use the left and right buttons to change.

OSD: 4K Ready – Day/Night

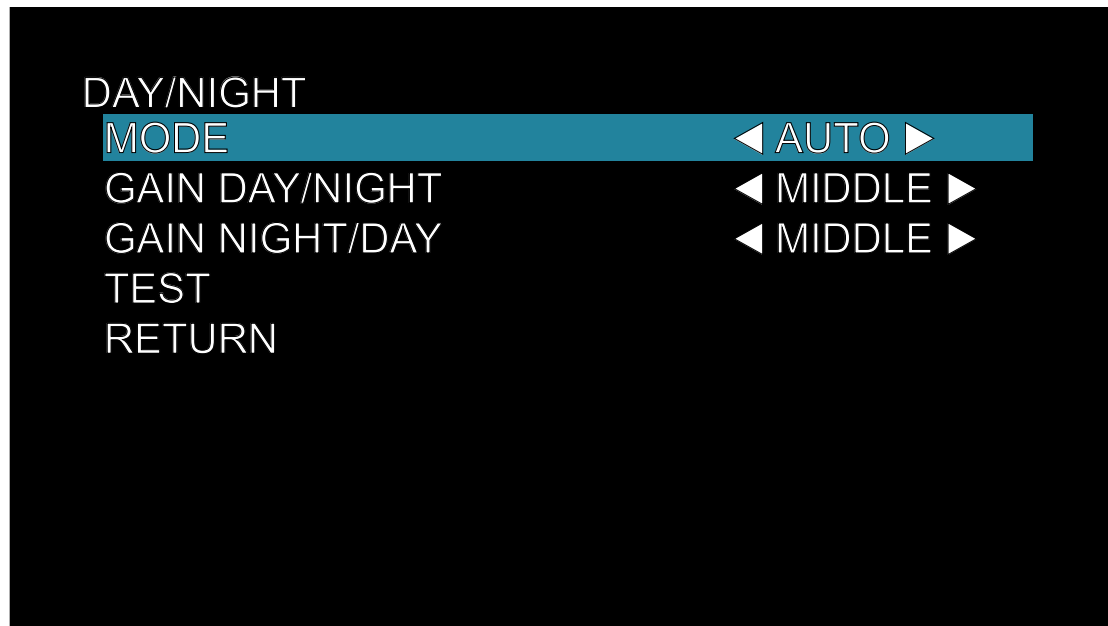

Auto: The camera determines when to switch from day to night and back to day. Auto is the best option as this will display color during the day and black & white at night.

Color: The camera will operate in color mode only. In low-light conditions, the color will be faint. Only visible light will be detected.

Mono: The camera will operate in night mode only and the image will be in black & white during the day.

Gain Day/Night: This controls the camera's duration (switch time) when changing from day to night mode. The default selection will suit most locations.

Gain Night/Day: This controls the camera's duration (switch time) when changing from night to day mode. The default selection will suit most

locations.

Test: This will test the settings that have been changed.

Return: Select this to go back to the Main Menu.

OSD: 4K Ready - Image Enhance

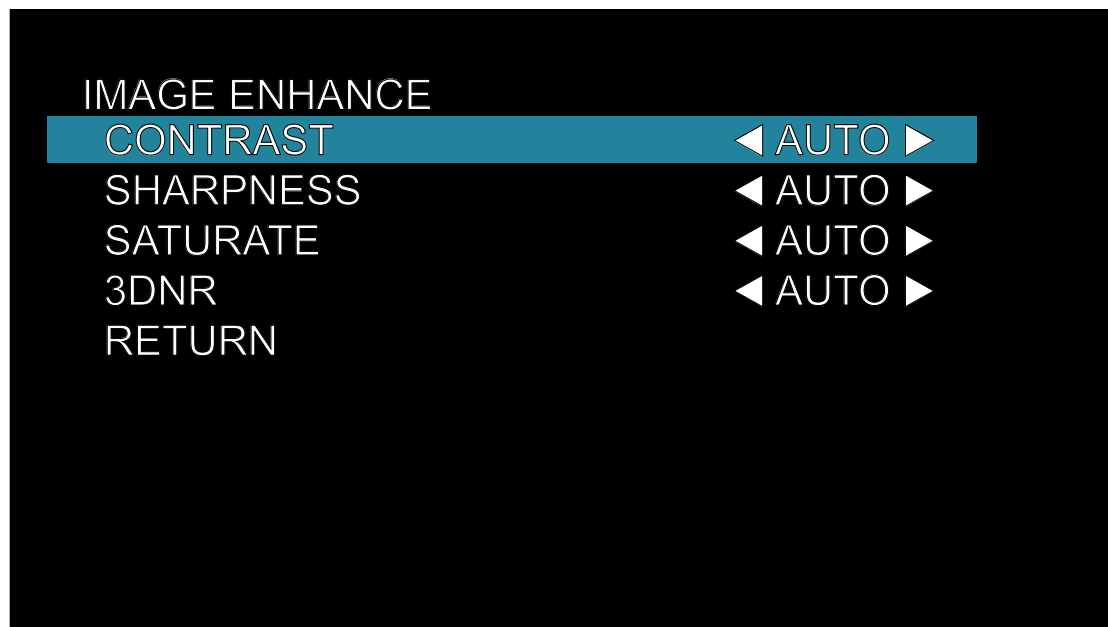

Contrast: This affects the color difference of the camera. The default selection will suit most locations. To change, select "MANUAL". A lower setting will make the image more gray and blended, while a higher setting will make the light and dark areas of the image more pronounced.

Sharpness: This affects the clarity of detail and edges in the image. The default selection will suit most locations. To change, select "MANUAL". Setting the sharpness too high will make the image and especially edges look pixelated. Setting it too low will result in a soft and slightly blurry image.

Saturate: More commonly known as saturation, the amount of color amplification in the image. The default selection will suit most locations. To change, select "MANUAL". Higher values will make the color more vivid, but can result in color bleed (where the color is projected outward slightly from

the edges of an object). Set a value that makes the colors look right.

3DNR (3D Noise Reduction): Lets you turn on the camera's 3D filtering system to assist in obtaining low-noise images for recordings done during the night or in dim conditions. The default selection will suit most locations. To change, select "MANUAL". Setting the value too high may cause a motion blur appearing on-screen on moving objects.

Return: Select this to go back to the Main Menu.

OSD: 2K Series - Main Menu



When accessing the OSD, the Main Menu will appear first. From here you can access the various settings available.

1. Indicates the option or setting selected.

2. Indicates a sub-menu is accessible.

Exposure: This setting determines how light or dark the image will appear.

Backlight: Improves exposure of an object that is in front of a light source. This may happen if an object is in front of a window. The camera will pickup the natural light, therefore the object or person in the foreground becomes dark. If the camera is mounted in a location where this is required, change this to BLC (back light compensation). Click the middle button to enter the sub-menu (for further instructions [click here](#)).

White Bal (Balance): This setting controls the white balance so that objects that appear white in person are rendered white within the image.

Day & Night: Choose how the camera manages the transition from day to night and back again.

NR (Noise Reduction): Is the process of removing noise from a signal.

Special: Gives you access to the mirror function, to enable dead pixel correction and language selection.

Adjust: Gives you access to settings such as sharpness and color gain.

Exit: If any of the settings are changed, select SAVE & END. To exit without saving, select NOT SAVE. To reset the camera back to default settings, select RESET.

OSD: 2K Series - Exposure

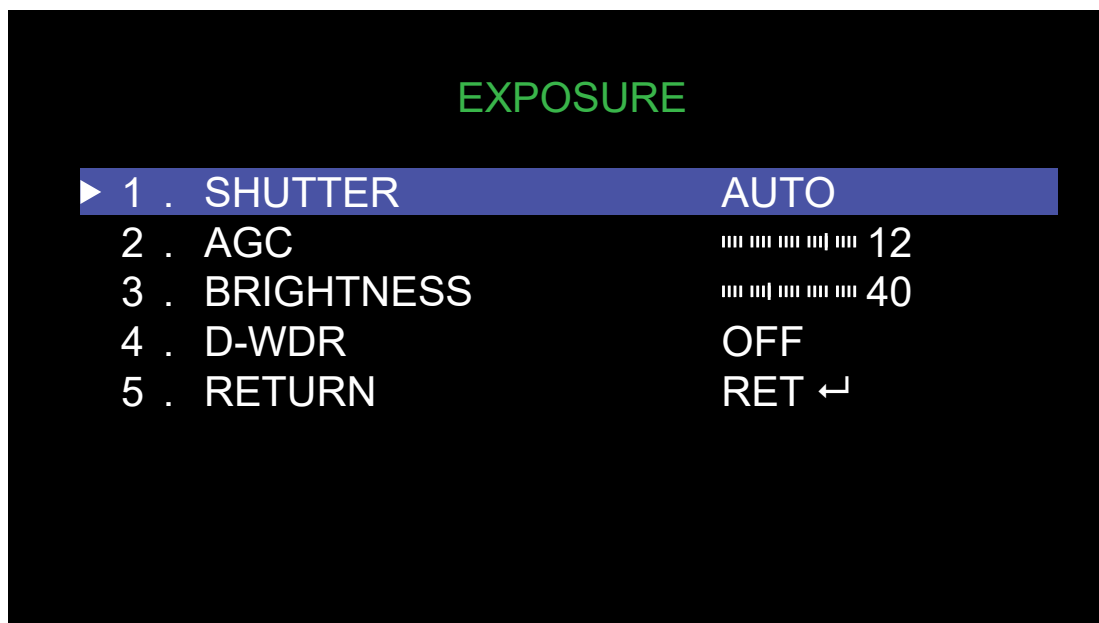

Shutter: In most circumstances the default setting should be suitable, however if the picture is flickering, change this to FLK (flicker-less mode).

AGC (Automatic Gain Control): This allows an increase in sensitivity, enabling operation in lower light conditions. Use the left and right buttons to decrease or increase the gain level. Just be aware that increasing the gain too high will also increase the video noise visible.

Brightness: This changes how light the image appears to be. Use the left and right buttons to decrease or increase the brightness level.

D-WDR (Wide Dynamic Range): This will balance out images that have a large dynamic range. An example of this would be if an indoor camera is pointing towards a window or building entrance. The image produced by the camera during the day would be extremely washed out due to the high

brightness of the incoming light. If the camera is mounted in a location where this is required, change this to AUTO.

Return: Select this to go back to the previous menu. If any of the settings are changed, select SAVE & END.

OSD: 2K Series - Backlight: BLC

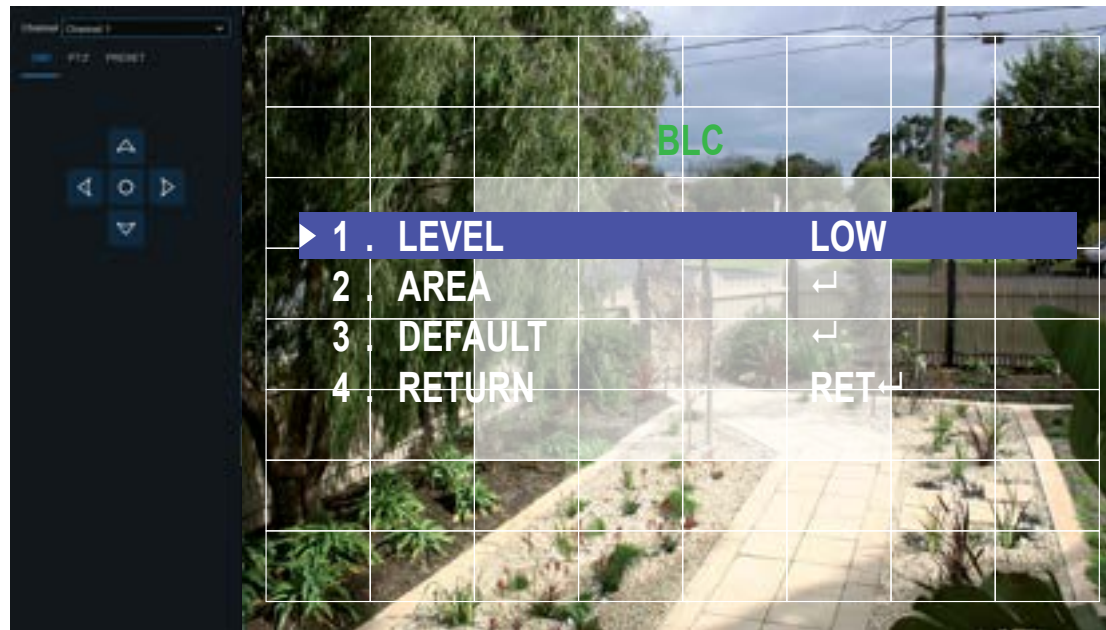

Level: Select the level of back light compensation that you would like to apply. Some experimentation is recommended to select the best setting.

Area: This function allows you to reposition and or resize the BLC region. You will see a 8x8 grid with the shaded area representing the BLC region. Click the middle button to change (for further instructions [click here](#)).

Default: This will reset any settings changed.

Return: Select this to go back to the previous menu. If any of the settings are changed, select SAVE & END.

OSD: 2K Series - Backlight: BLC - Area



Position: Use the directional buttons to move the camera's BLC region along the grid displayed (you will see the word POSITION). When finished, click the middle button.

Size: Use the directional buttons to resize the camera's BLC region along the grid displayed (you will see the word SIZE). When finished, click the middle button.

Some experimentation is required to get the correct position and size required. Click the middle button again to exit.

OSD: 2K Series - White Bal (Balance)



ATW (Auto Tracking White Balance): By default, the camera's white balance is set to ATW to detect when the ambient light shifts significantly and changes the white balance automatically.

AWC (Auto White Balance Control): This is suitable for a location where the light source is stable. To set the white balance, hold a white card or paper in front of the camera then click the middle button. The camera will register that color as "white" and will adjust the white balance accordingly.

Indoor: Select this if the camera will be mounted indoor.

Outdoor: Select this if the camera will be mounted outdoor.

Manual: This will set the white balance by adjust the red and blue gains. Click the middle button to adjust. If you think the color in the image has too much red or too little red, use the left and right buttons to change. If you think the

color in the image has too much blue or too little blue, use the left and right buttons to change.

Return: Select this to go back to the previous menu. If any of the settings are changed, select SAVE & END.

OSD: 2K Series - Day&Night: Ext

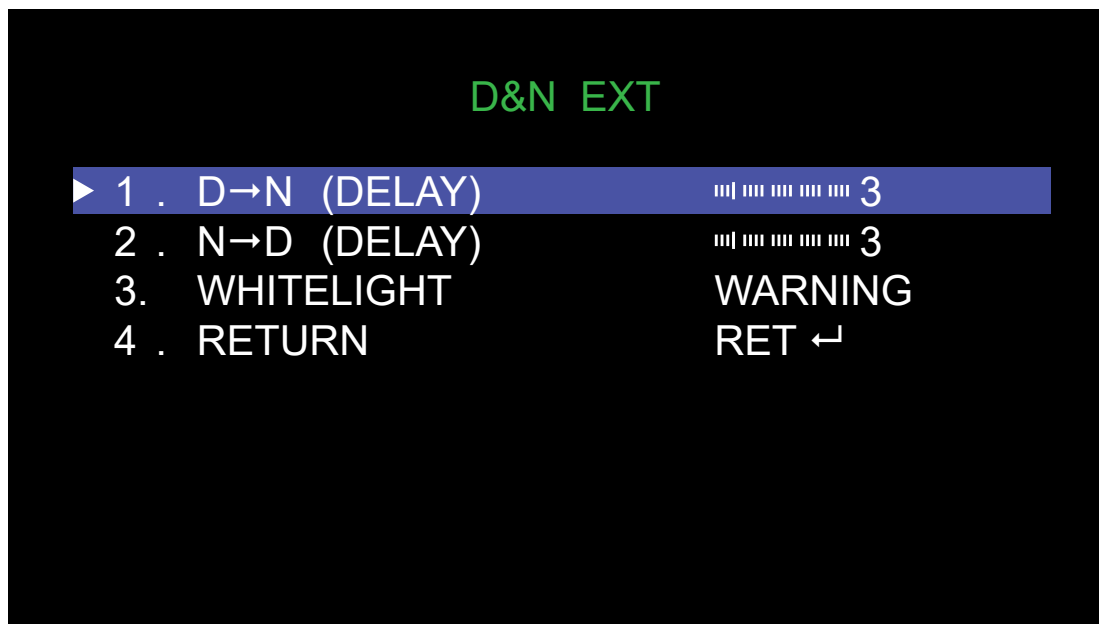

The EXT setting enables the camera to switch between day and night using the camera's external sensor. Click the middle button to change settings.

D→N (Delay): Controls the delay of the external sensor when transitioning from day to night. Use the left and right buttons to change. The higher the number, the greater the delay.

N→D (Delay): Same as above but the transition is from night to day.

Whitelight: This setting has no function with this model camera.

Return: Select this to go back to the previous menu. If any of the settings are changed, select SAVE & END.

OSD: 2K Series - Day&Night: Auto

D&N AUTO

▶ 1 . D→N (AGC)	150
2 . D→N (DELAY)	3
1 . N→D (AGC)	82
2 . N→D (DELAY)	3
4 . RETURN	RET ↵

For this particular model, the AUTO setting is not supported.

OSD: 2K Series - Day&Night: Color

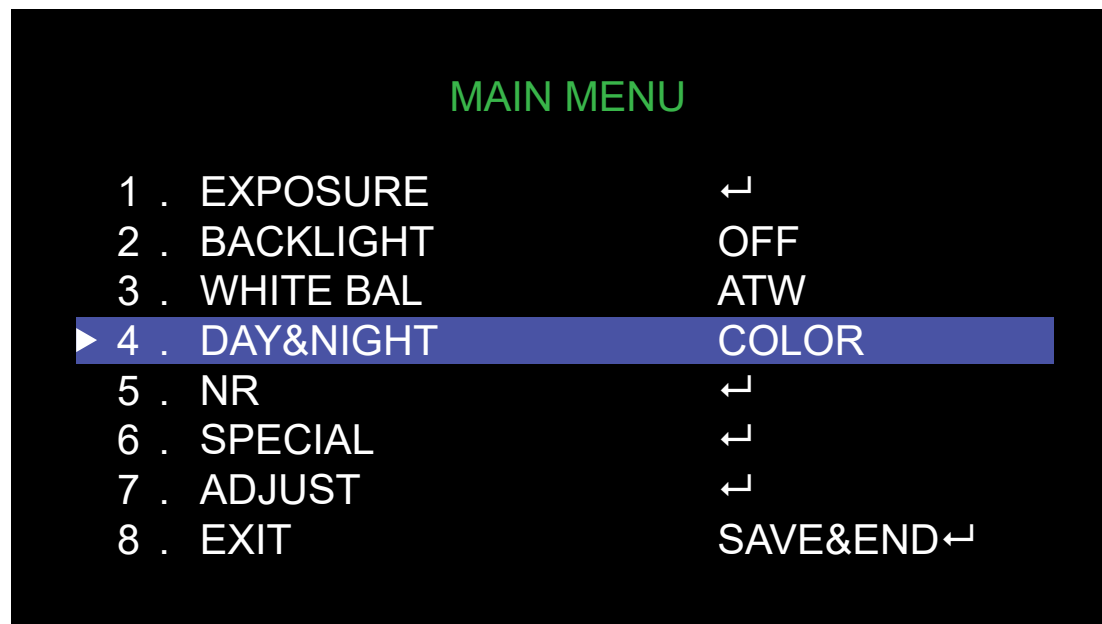

This will instruct the camera to operate in color mode only. In low-light conditions, the color will be quite faint. Image clarity will also be reduced in low-light conditions.

OSD: 2K Series - Day&Night: B/W



The B/W setting will instruct the camera to operate in black & white mode only. Click the middle button to change settings.

IR Smart: By default, the camera will adjust the intensity of its infrared LEDs to compensate for the distance of an object so that the infrared does not over-expose the object. It's recommended to leave this enabled.

IR PWM (Pulse Width Modulation): For this particular model, this setting is not supported.

Return: Select this to go back to the previous menu. If any of the settings are changed, select SAVE & END.

OSD: 2K Series - NR (Noise Reduction)

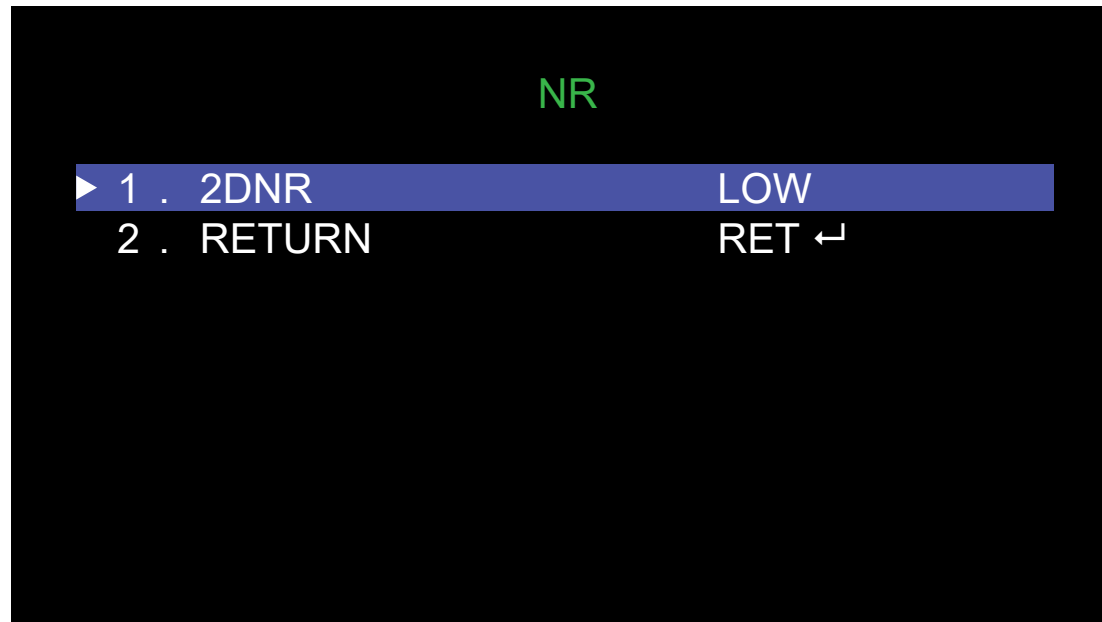

2DNR: 2D noise reduction analyzes individual frames of video, using a special algorithm filter to mitigate the effects of noise. Select the best setting for the camera's location.

Return: Select this to go back to the previous menu. If any of the settings are changed, select SAVE & END.

OSD: 2K Series - Special

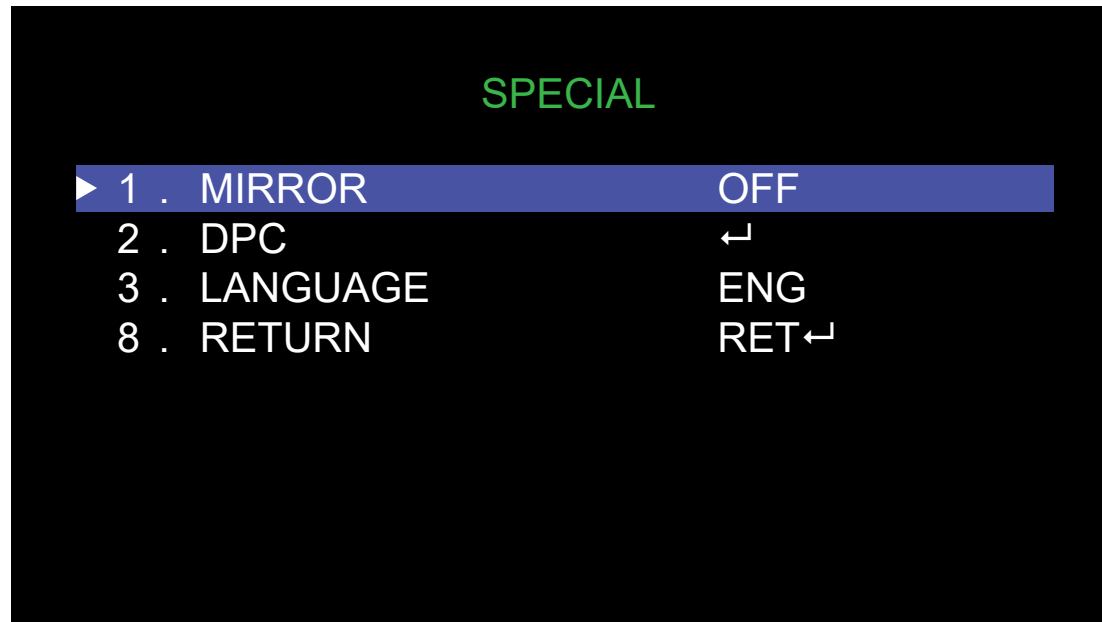

Mirror: Depending on how the camera is mounted, this will change the camera's orientation. There are three orientations available.

DPC (Dead Pixel Correction): Sometimes video sensors can develop a dead pixel. This does not disable the camera but may make the image a little annoying to look at. This setting will find any dead pixels and mark them digitally. Enable this function if any dead pixels are visible.

Language: Indicates the language used for the OSD. Several languages are available.

Return: Select this to go back to the previous menu. If any of the settings are changed, select SAVE & END.

OSD: 2K Series - Adjust

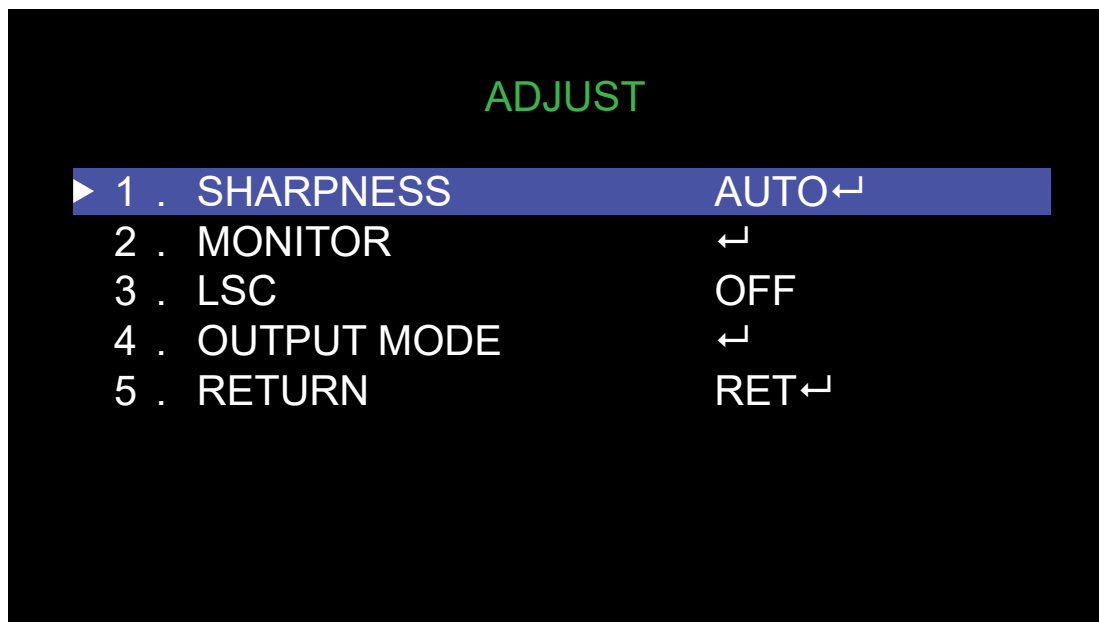

Sharpness: The clarity of detail and edges in the image. You can select LOW, MIDDLE or HIGH. Setting the sharpness high may make the image and especially edges look pixelated. Setting the sharpness low may result in a soft image. Select the best setting for the camera's location.

Monitor: Click here for more information.

LSC (Lens Shading Correction): If the periphery or outer image of the camera is darkened or blurred, enable this setting.

Output Mode: Click here for more information.

Return: Select this to go back to the previous menu. If any of the settings are changed, select SAVE & END.

OSD: 2K Series - Adjust: Monitor

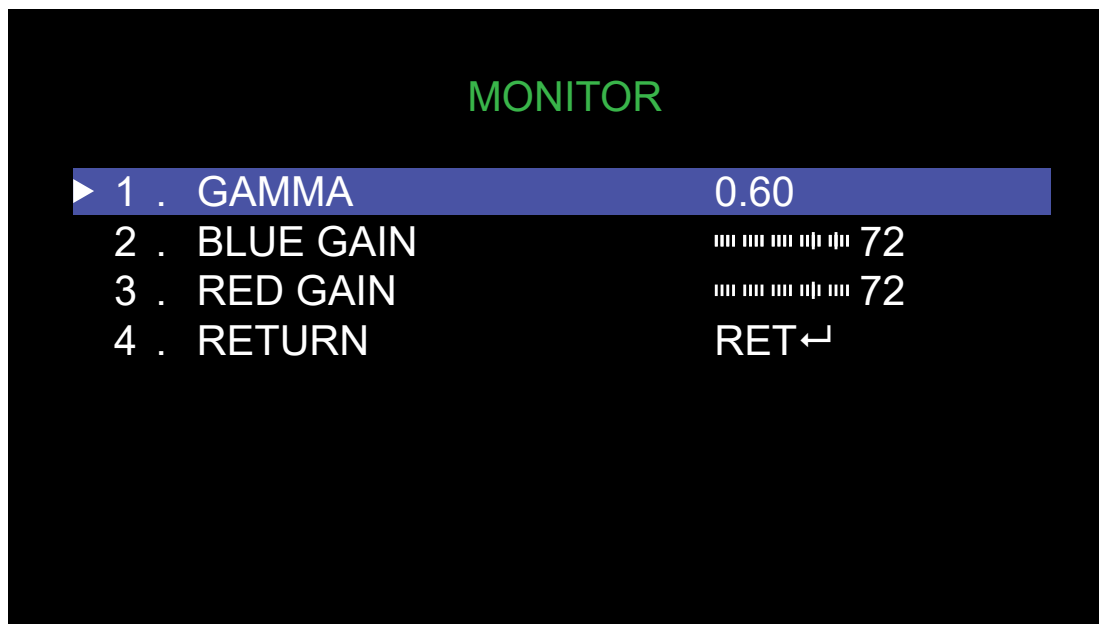

Gamma: This will balance the brightness seen by the camera to that of the TV your DVR is connected to. Adjust accordingly.

Blue Gain: If you think the color in the image has too much blue or too little blue, use the left and right buttons to change.

Red Gain: If you think the color in the image has too much red or too little red, use the left and right buttons to change.

Return: Select this to go back to the previous menu. If any of the settings are changed, select SAVE & END.

OSD: 2K Series - Adjust: Output Mode

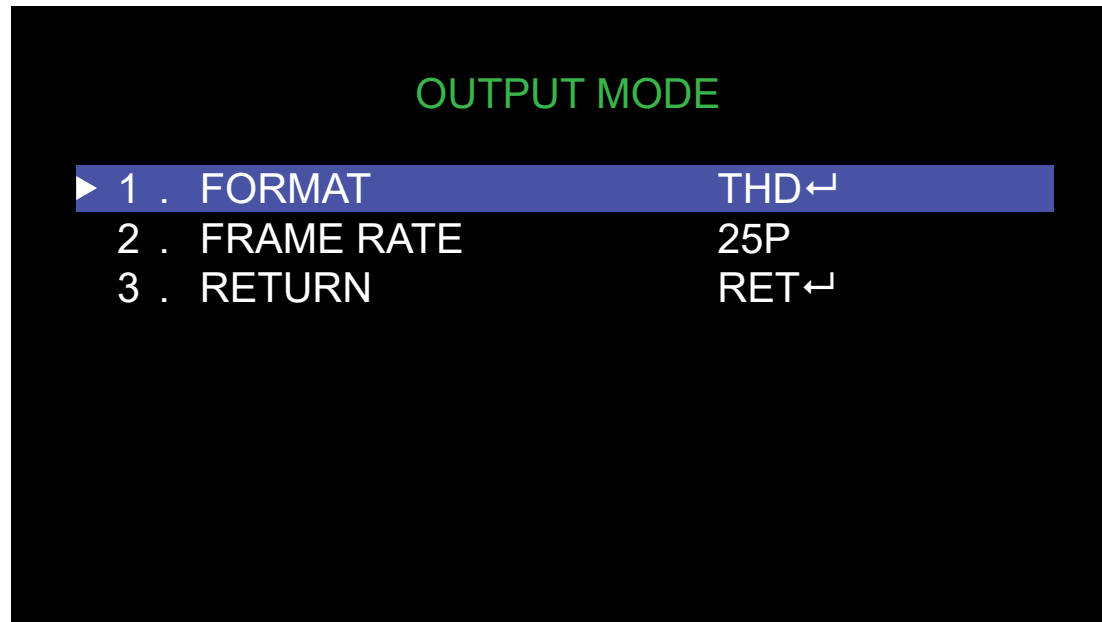

Format: This camera only operate in THD mode and cannot be changed.

Frame Rate: The maximum frame rate that the camera can support is displayed. Please note, the frame rate for recording is set by your DVR.

Return: Select this to go back to the previous menu. If any of the settings are changed, select SAVE & END.

Analytics

Analytics provides you with much greater control on how your DVR detects motion. By drawing a detection line, you can apply a rule on which direction your DVR detects motion. You can define specific areas that you want to monitor for motion and select which direction an object can enter or exit the region defined. You can also monitor static objects in and around your home by drawing an area around an object. Protect valuables or use it on your porch to detect a parcel delivered.



TIP

The analytic functions can only be enabled for a single channel at a time.

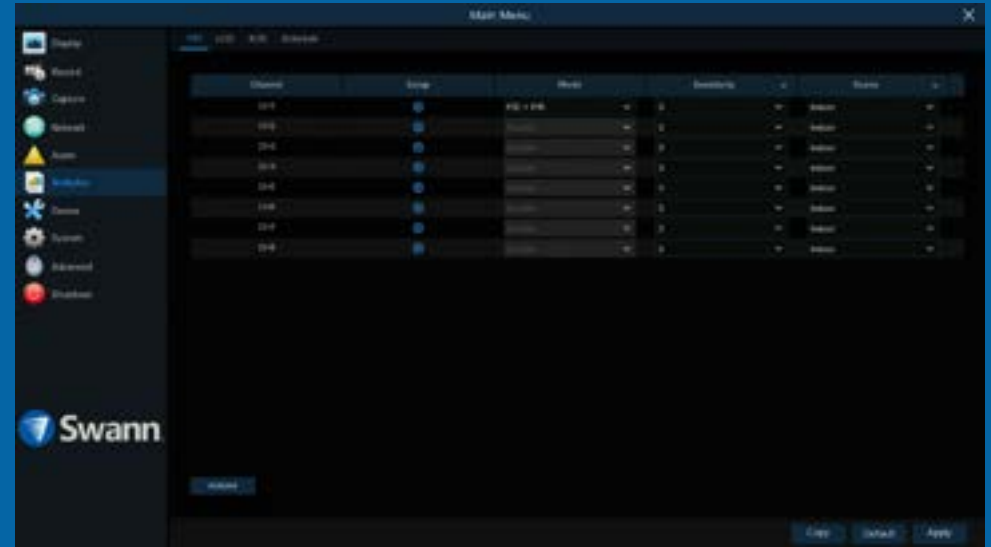

Analytics: PID (Perimeter Intrusion Detection)

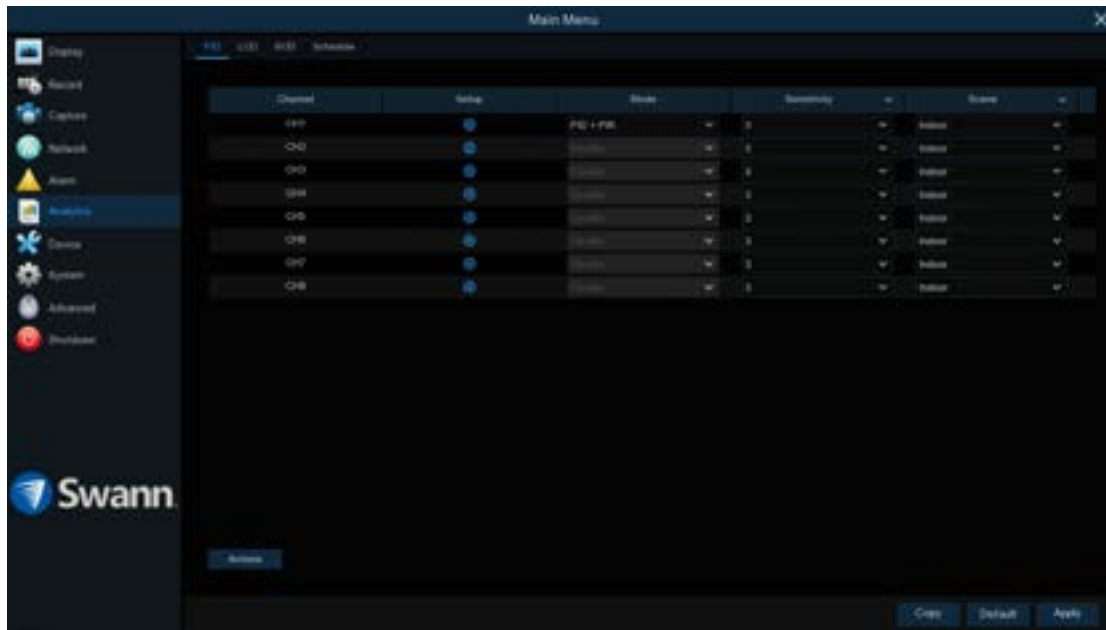

A perimeter intrusion region can be used to define specific areas that you want to monitor for motion. For example, a rule can be defined so that your DVR will alert you if one or more objects have stayed within the intrusion region for a particular time. You can also select which direction an object can enter and or exit.

- Use the “Copy” function to apply all settings to the other cameras connected.
- Click “Default” to revert to default settings.
- Click “Apply” to save settings.

Each camera input on your DVR will be displayed as CH1, CH2, etc.

Setup: Click the button to draw one or more perimeter intrusion regions (see page 82 - [Drawing a Perimeter Intrusion Region](#)).

Mode: Two choices are available. Select “PID” to receive alerts when motion has been detected. Select “PID+PIR” to receive alerts when motion has been detected by the camera and the camera’s built-in PIR sensor.

Sensitivity: Adjust the sensitivity level of the perimeter intrusion region. The higher the number, the more sensitive the intrusion region will be.

Scene: Select the appropriate setting for where the camera is located.

Actions: Click the button to change options for alarm notifications, alerts and more (see page 81 - [Analytics: PID \(Perimeter Intrusion Detection\) - Actions](#)).



TIP

When motion has been detected by one of the analytic functions, a green or red “S” will appear in Live View Mode. Green indicates that the DVR isn’t recording and red indicates that the DVR is recording.

Analytics: PID (Perimeter Intrusion Detection) - Actions

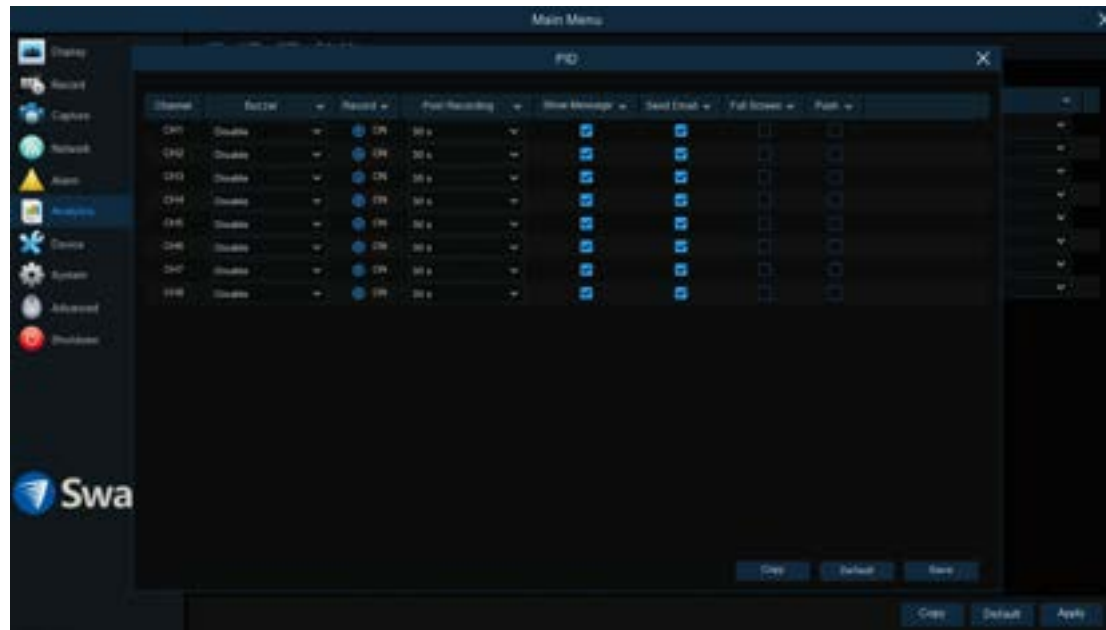

Buzzer: When motion has been detected, you can enable the DVR's buzzer to alert you for a predetermined amount of time. Click the drop down menu to select a time.

Record (Record Channel & Analog Channels): This option instructs your DVR to trigger additional cameras to start recording when motion has been detected. Click the "Analog Channels" checkbox to select all cameras or click on the individual camera number that you want to trigger for recording.

Post Recording: This option instructs your DVR to record for a set period of time after an event has occurred. For most instances, the default selection will be suitable, however you can change this if you wish.

Show Message: The motion icon will appear on-screen when motion has been detected. Click the checkbox if you want to disable this.

Send Email: An email alert will be sent when motion has been detected. Click the checkbox if you want to disable this.

Full Screen: Click the checkbox to view the camera full-screen in Live View mode when motion has been detected.

Push: Click the checkbox to receive push notifications via the Swann Security app (a push notification is a message that pops up on your mobile device).

Click the "Save" button then click "OK". Right-click the mouse to exit.

Drawing a Perimeter Intrusion Region



To remove a perimeter intrusion region: Click the rule number checkbox to select then press the “Remove” button. Click “Remove All” if multiple regions have been drawn.

Rule Number: Click the drop down menu to select the rule number that you want to create. Up to four perimeter intrusion regions can be drawn.

Rule Switch: Leave this enabled.

Rule Type: There are three rule types that can be selected. Select the appropriate rule for the region created (each region can have a different rule).

A->B: Motion is detected when an object has crossed the line from direction A only.

B->A: Motion is detected when an object has crossed the line from direction B only.

A<->B: Motion is detected when an object has crossed the line from both directions.

Using the mouse, you need to create four points to draw a perimeter intrusion region (it can be drawn at any size). Your DVR does not allow lines to be crossed when drawing an intrusion region.

As illustrated above left, click once at the start point then move right and click once to create the second point. Move the mouse down and click once to create the third point then move left and click once to create the fourth point.

Remove: See above right example.

Remove All: Click this to remove all perimeter intrusion regions.

Save: Click this to save any changes made then click “OK” to continue.

Right-click to exit.

Analytics: LCD (Line Crossing Detection)

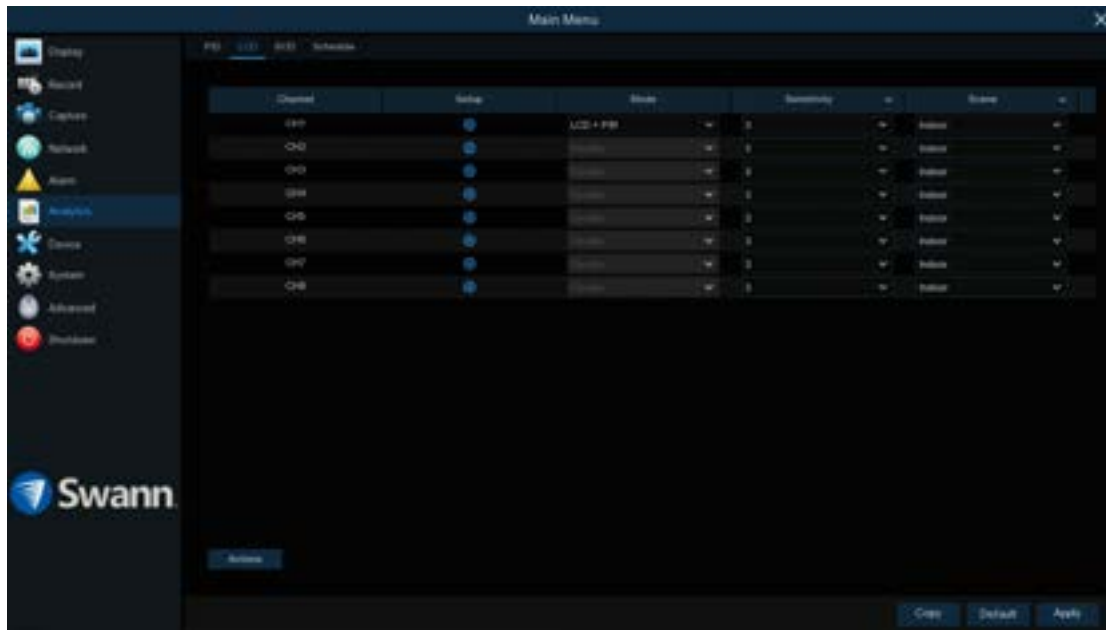

By drawing a detection line (it can be drawn at any orientation, length or angle), you can apply a rule on which direction your DVR detects motion. As an example, this can be used to detect people jumping a fence or entering and or exiting a doorway.

- Use the “Copy” function to apply all settings to the other cameras connected.
- Click “Default” to revert to default settings.
- Click “Apply” to save settings.

Each camera input on your DVR will be displayed as CH1, CH2, etc.

Setup: Click the “Setup” button to draw one or more detection lines (see page 85 - [Drawing a Detection Line](#)).

Mode: Two choices are available. Select “LCD” to receive alerts when motion has been detected. Select “LCD+PIR” to receive alerts when motion has been detected by the camera and the camera’s built-in PIR sensor.

Sensitivity: Adjust the sensitivity level of the detection line. The higher the number, the more sensitive the detection will be.

Scene: Select the appropriate setting for where the camera is located.

Actions: Click the button to change options for alarm notifications, alerts and more (see page 84 - [Analytics: LCD \(Line Crossing Detection\) - Actions](#)).



TIP

When motion has been detected by one of the analytic functions, a green or red “S” will appear in Live View Mode. Green indicates that the DVR isn’t recording and red indicates that the DVR is recording.

Analytics: LCD (Line Crossing Detection) - Actions

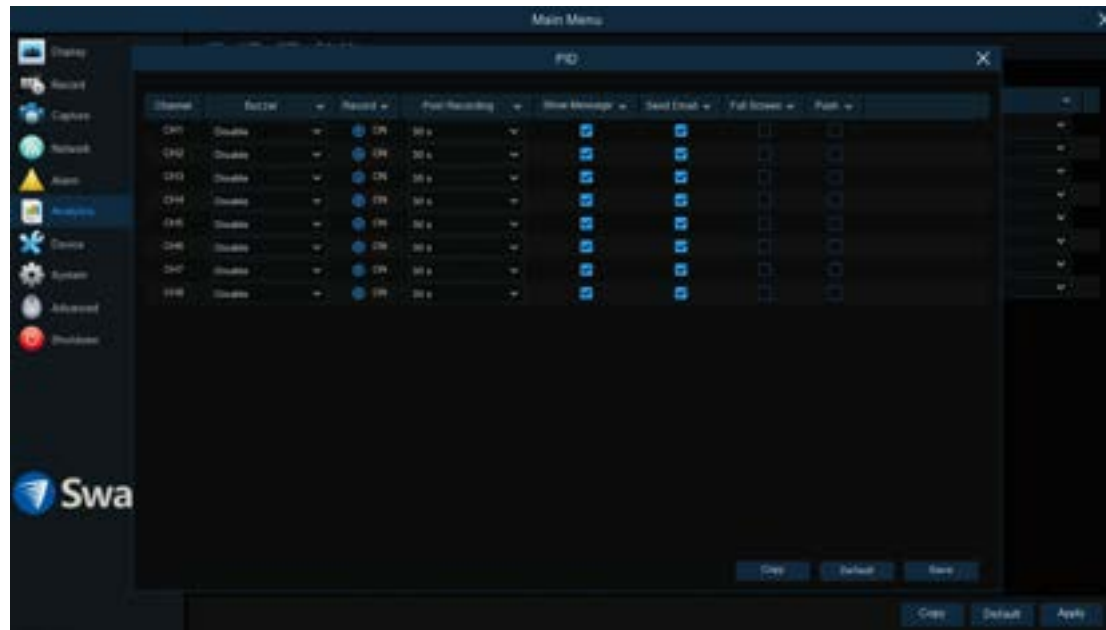

Buzzer: When motion has been detected, you can enable the DVR's buzzer to alert you for a predetermined amount of time. Click the drop down menu to select a time.

Record (Record Channel & Analog Channels): This option instructs your DVR to trigger additional cameras to start recording when motion has been detected. Click the "Analog Channels" checkbox to select all cameras or click on the individual camera number that you want to trigger for recording.

Post Recording: This option instructs your DVR to record for a set period of time after an event has occurred. For most instances, the default selection will be suitable, however you can change this if you wish.

Show Message: When motion has been detected, the motion icon will appear on-screen. Click the checkbox if you want to disable this.

Send Email: Click the checkbox to enable your DVR to send an email alert when motion has been detected.

Full Screen: Click the checkbox to view the camera full-screen in Live View mode when motion has been detected.

Push: Push notifications are automatically sent via the Swann Security app. Click the checkbox if you want to disable this.

Click the "Save" button then click "OK". Right-click the mouse to exit.

Drawing a Detection Line

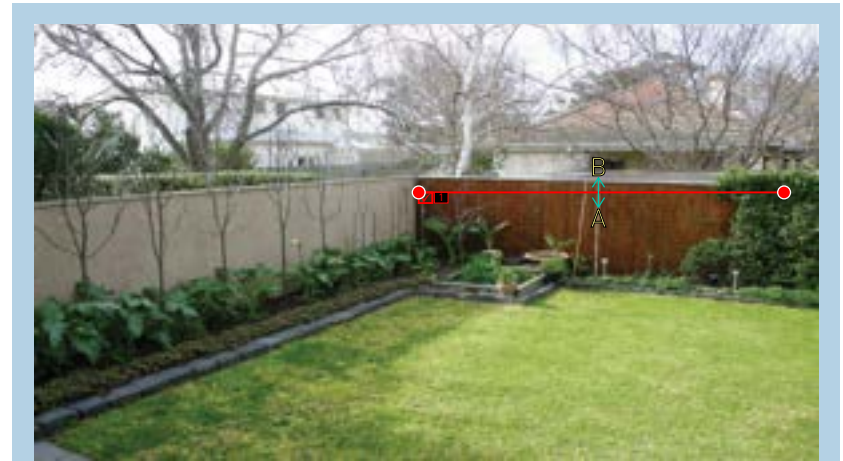

To remove a detection line: Click the rule number check-box to select then press the “Remove” button. Click “Remove All” if multiple lines have been drawn.

Rule Number: Click the drop down menu to select the rule number that you want to create. Up to four detection lines can be drawn.

Rule Switch: Leave this enabled.

Rule Type: There are three rule types that can be selected. Select the appropriate rule for the line drawn (each line can have a different rule).

A->B: Motion is detected when an object has crossed the line from direction A only.

B->A: Motion is detected when an object has crossed the line from direction B only.

A<->B: Motion is detected when an object has crossed the line from both directions.

Using the mouse, click once at the start point then click again at the end point. A detection line will be drawn between the two points. Direction A and direction B will be shown, denoting the rule that you can apply to the detection line. A detection line can be drawn at any orientation, length or angle.

As illustrated above left, a detection line has been drawn across the fence line. When selecting rule B->A, motion is detected when an object has crossed the line from direction B only.

Remove: See above right example.

Remove All: Click this to remove all detection lines.

Save: Click this to save any changes made then click “OK” to continue.

Right-click to exit.

Analytics: SOD (Stationary Object Detection)

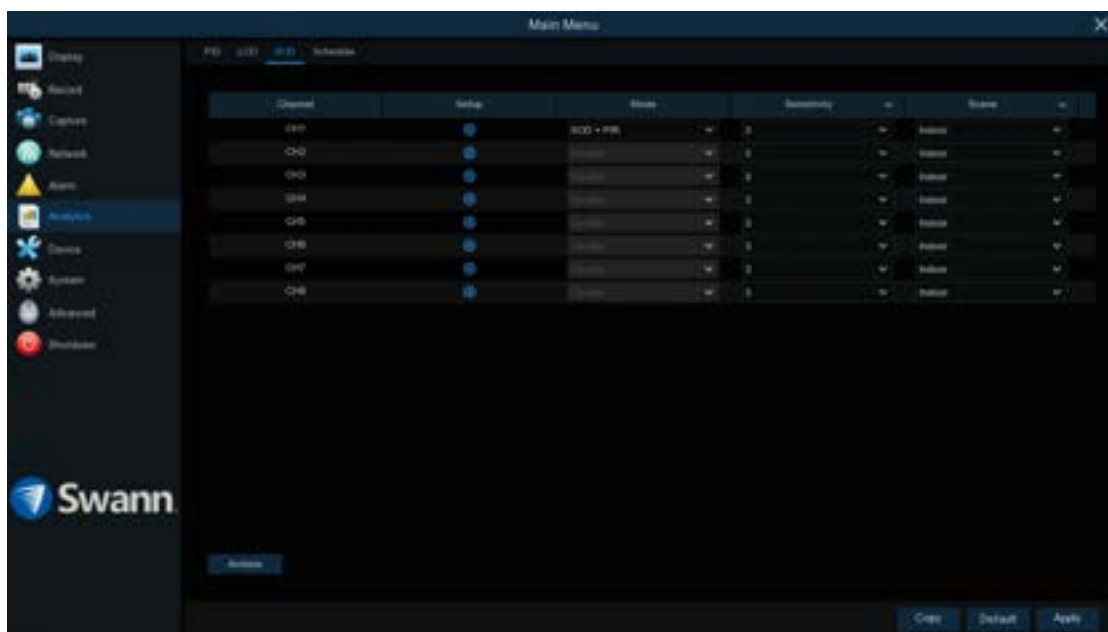

This function can be used to monitor static objects in and around your home. By drawing an area around an object, if that object is removed, your DVR will trigger recording and alert you to an event. Protect valuables or use it on your porch to detect a parcel delivered.

- Use the “Copy” function to apply all settings to the other cameras connected.
- Click “Default” to revert to default settings.
- Click “Apply” to save settings.

Each camera input on your DVR will be displayed as CH1, CH2, etc.

Setup: Click the “Setup” button to draw one or more detection lines (see page 88 - [Drawing an Object Detection Region](#)).

Mode: Two choices are available. Select “SOD” to receive alerts when motion has been detected. Select “SOD+PIR” to receive alerts when motion has been detected by the camera and the camera’s built-in PIR sensor.

Sensitivity: Adjust the sensitivity level of the object detection region. The higher the number, the more sensitive the detection will be.

Scene: Select the appropriate setting for where the camera is located.

Actions: Click the button to change options for alarm notifications, alerts and more (see page 87 - [Analytics: SOD \(Stationary Object Detection\) - Actions](#)).



TIP

When motion has been detected by one of the analytic functions, a green or red “S” will appear in Live View Mode. Green indicates that the DVR isn’t recording and red indicates that the DVR is recording.

Analytics: SOD (Stationary Object Detection) - Actions

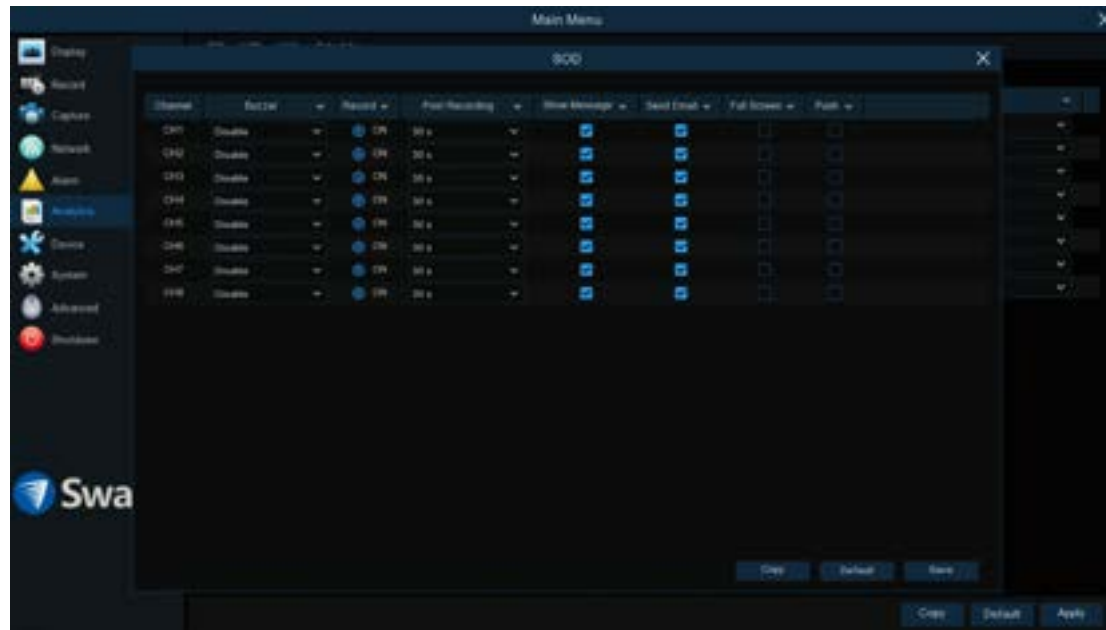

Buzzer: When motion has been detected, you can enable the DVR's buzzer to alert you for a predetermined amount of time. Click the drop down menu to select a time.

Record (Record Channel & Analog Channels): This option instructs your DVR to trigger additional cameras to start recording when motion has been detected. Click the "Analog Channels" checkbox to select all cameras or click on the individual camera number that you want to trigger for recording.

Post Recording: This option instructs your DVR to record for a set period of time after an event has occurred. For most instances, the default selection will be suitable, however you can change this if you wish.

Show Message: The motion icon will appear on-screen when motion has been detected. Click the checkbox if you want to disable this.

Send Email: An email alert will be sent when motion has been detected. Click the checkbox if you want to disable this.

Full Screen: Click the checkbox to view the camera full-screen in Live View mode when motion has been detected.

Push: Click the checkbox to receive push notifications via the Swann Security app (a push notification is the delivery of information to a mobile device from an application server).

Click the "Save" button then click "OK". Right-click the mouse to exit.

Drawing an Object Detection Region



To remove an object detection region: Click the rule number checkbox to select then press the “Remove” button. Click “Remove All” if multiple regions have been drawn.

Rule Number: Click the drop down menu to select the rule number that you want to create. Up to four object detection regions can be drawn.

Rule Switch: Leave this enabled.

Rule Type: Only one rule type is available.

Taken & Left: An event will occur when an object has been taken or removed and or when an object has been left within the object detection region.

Using the mouse, you need to create four points to draw an object detection region (it can be drawn at any size). Your DVR does not allow lines to be crossed when drawing a detection region. Make sure the detection region is greater than or equal to the size of the detected object.

As illustrated above left, click once at the start point then move right and

click once to create the second point. Move the mouse down and click once to create the third point then move left and click once to create the fourth point.

Remove: See above right example.

Remove All: Click this to remove all object detection regions.

Save: Click this to save any changes made then click “OK” to continue.

Right-click to exit.

Analytics: Schedule

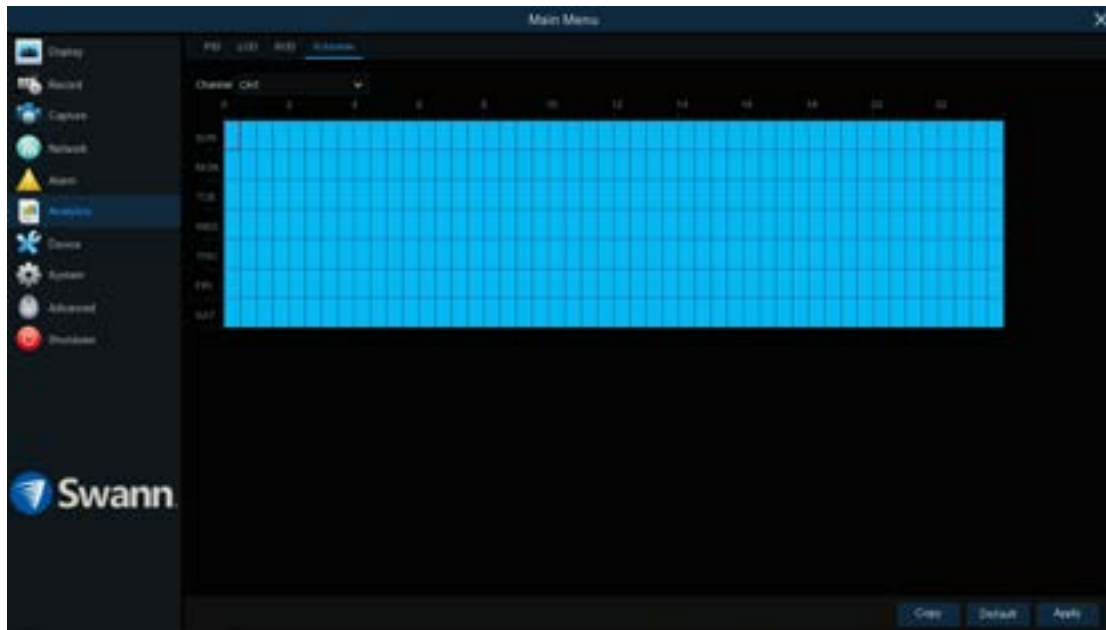

To record events that are detected using the analytic functions available, an analytic recording schedule must be created for cameras that have the PID, LCD and SOD functions enabled. Each camera can have a different recording schedule if needed.

- Use the “Copy” function to apply all settings to the other cameras connected.
- Click “Default” to revert to default settings.
- Click “Apply” to save settings.

Channel: Select a camera that you would like to edit.

Each square represents 30 minutes. Using the mouse, click on a particular square to change or click and drag the mouse over the squares corresponding to your desired time period. The same action can also be applied if a recording schedule is not required (on one or more sections that have been enabled).



TIP

An analytic recording schedule must be created, otherwise your DVR will not record an event when motion has been detected via the analytic functions.

Recording Configuration

The recording configuration options are available in the Record and Capture menus that are accessible from the Main Menu. From here you can access and change the default recording schedule (presented as a 24 hour 7 days a week grid and is color coded) for each camera connected. You can also enable and set a schedule for your DVR to take a snapshot each time an event occurs.

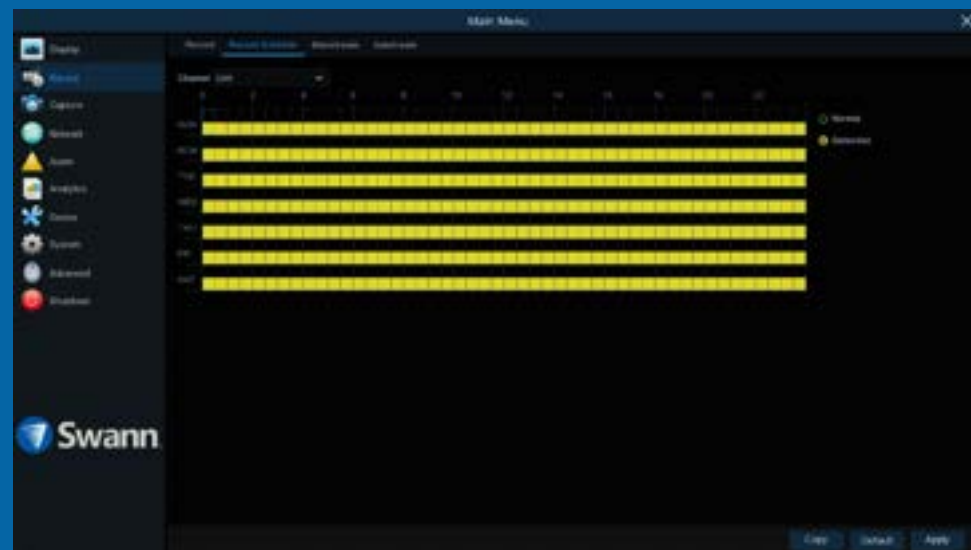
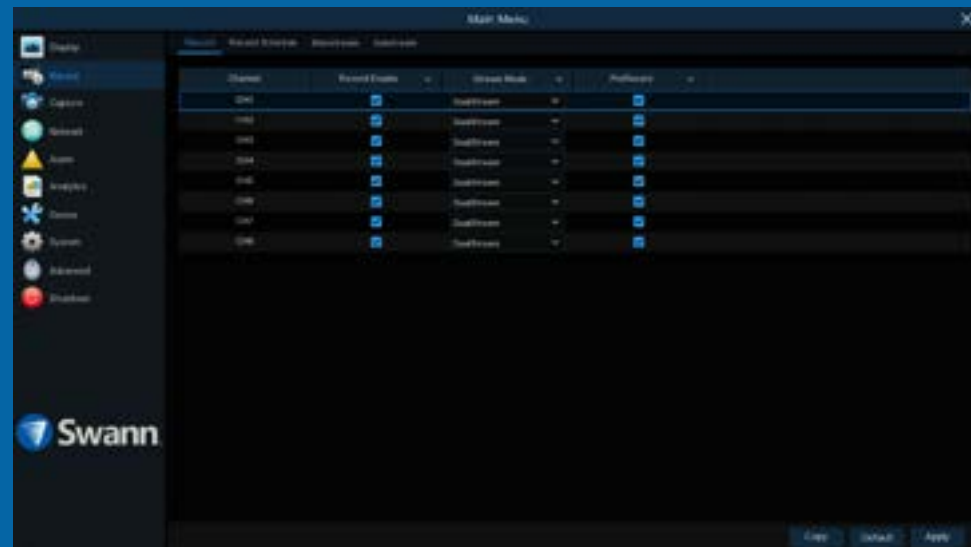

Record: Record

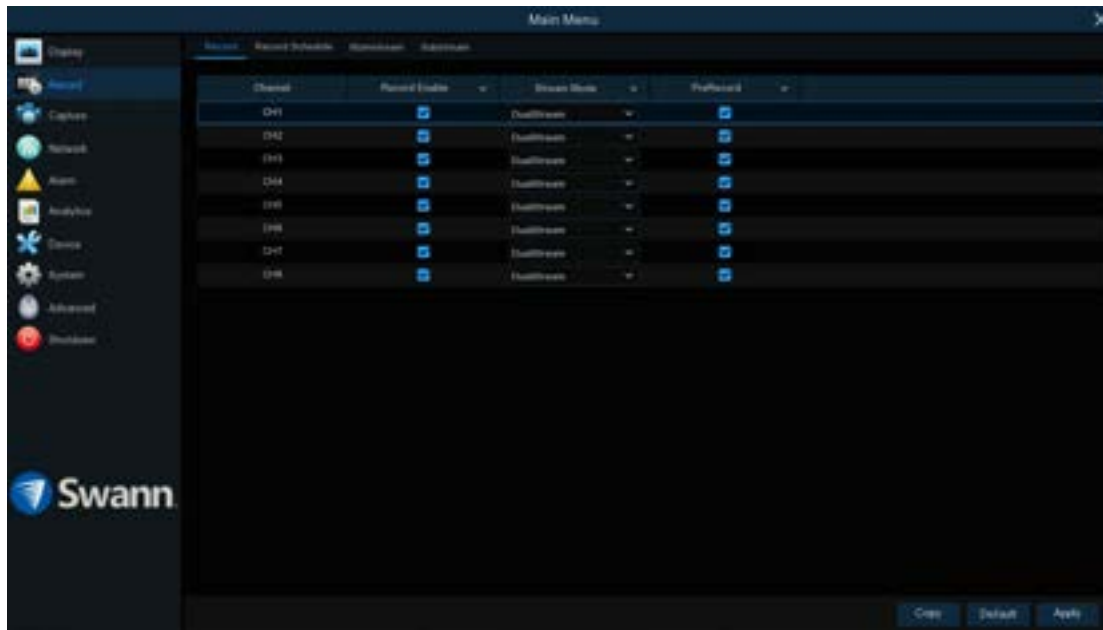

- Use the “Copy” function to apply all settings to the other cameras connected.
- Click “Default” to revert to default settings.
- Click “Apply” to save settings.

Each camera input on your DVR will be displayed as CH1, CH2, etc.

Record Enable: When disabled, your DVR will detect motion but it will not record (manual record is also disabled).

Stream Mode: By default, your DVR will record both Mainstream and Substream video (known as DualStream). Mainstream (high quality) video is used for playback when using your DVR directly, and Substream (reduced quality) is used for remote playback on your mobile device. If remote playback is not required, you can select Mainstream recording only.

PreRecord: Allows your DVR to record for a number of seconds before an event occurs. It's recommended to leave this enabled.

Record: Schedule

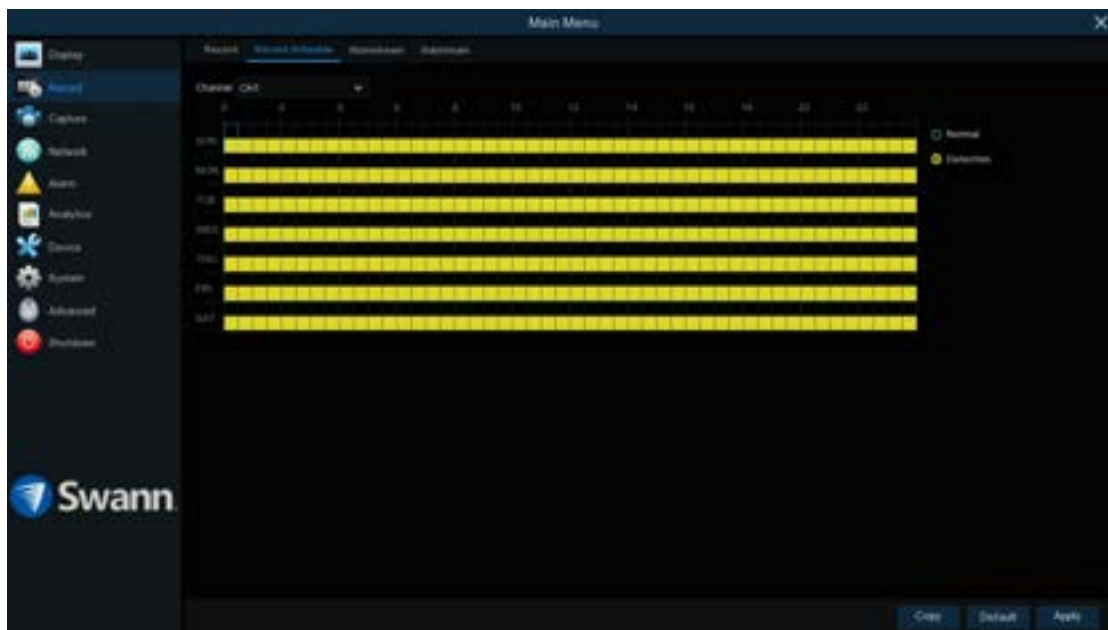

By default, a 24-hour 7 days a week Detection schedule has been enabled for each camera connected. The schedule can be changed to suit your needs and each camera can have a different schedule if needed. The schedule is color coded to represent the event type.

- Use the “Copy” function to apply all settings to the other cameras connected.
- Click “Default” to revert to default settings.
- Click “Apply” to save settings.

Channel: Select a camera that you would like to edit.

Normal: Your DVR will constantly record for a set period of time.

Detection: Your DVR will only record when motion has been detected from one or more cameras.

Each square represents 30 minutes. Using the mouse, select the desired recording mode then click on a particular square to change or click and drag the mouse over the squares corresponding to your desired time period. The same action can also be applied if Normal or Detection recording is not required (on one or more sections that have recording enabled).

Capture: Capture

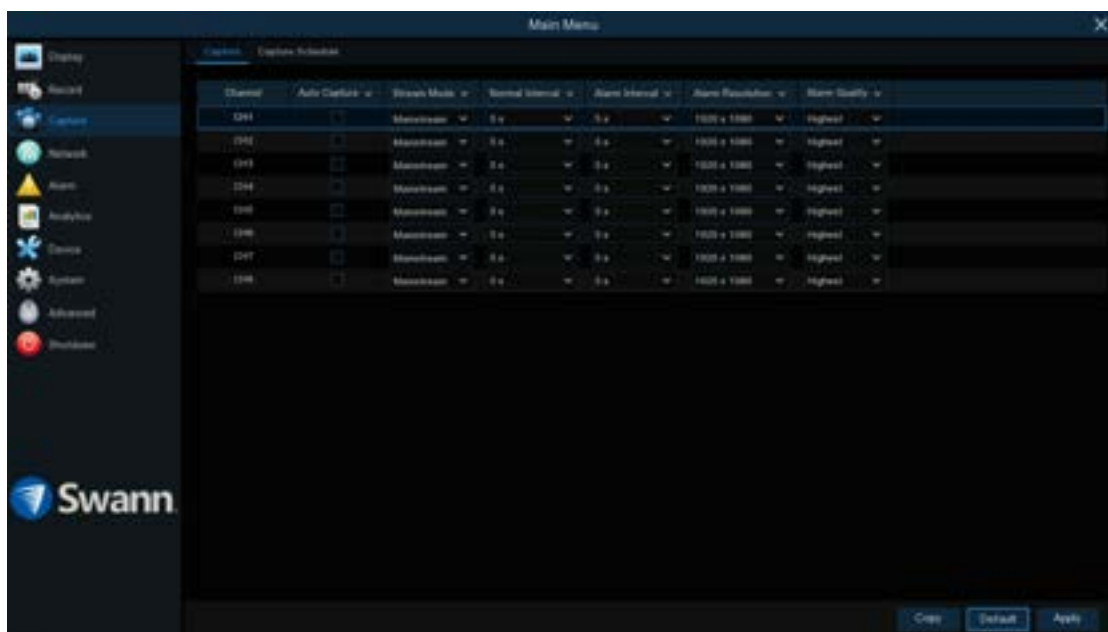

As an added feature, you can enable and set a schedule for your DVR to take a snapshot each time an event occurs. This is particularly useful for finding motion events quickly and can also be used for different purposes such as time lapse photography.

- Use the “Copy” function to apply all settings to the other cameras connected.
- Click “Default” to revert to default settings.
- Click “Apply” to save settings.

Each camera input on your DVR will be displayed as CH1, CH2, etc.

Auto Capture: When enabled, your DVR will take a snapshot each time an event occurs.

Stream Mode: Leave the default selection (Mainstream). This allows you to select the camera’s native resolution (Alarm Resolution).

Normal Interval: The length of time that must elapse before a snapshot is taken. For example, when setting a Normal capture schedule, a snapshot will be taken every 5 seconds using the default selection. Adjust accordingly.

Alarm Interval: When setting a Detection capture schedule, a snapshot will be taken each time motion has been detected according to the interval selected. Adjust accordingly.

Alarm Resolution: Leave the default selection (1920 x 1080). This will save each snapshot at the highest resolution available. A lower resolution can be selected.

Alarm Quality: Leave the default selection. This will save each snapshot at the camera’s highest bitrate (the amount of data that your DVR will use to take a snapshot).

As this is an added feature, a capture schedule is not enabled by default. To enable this (see page 94 – [Capture: Schedule](#)).

Capture: Schedule

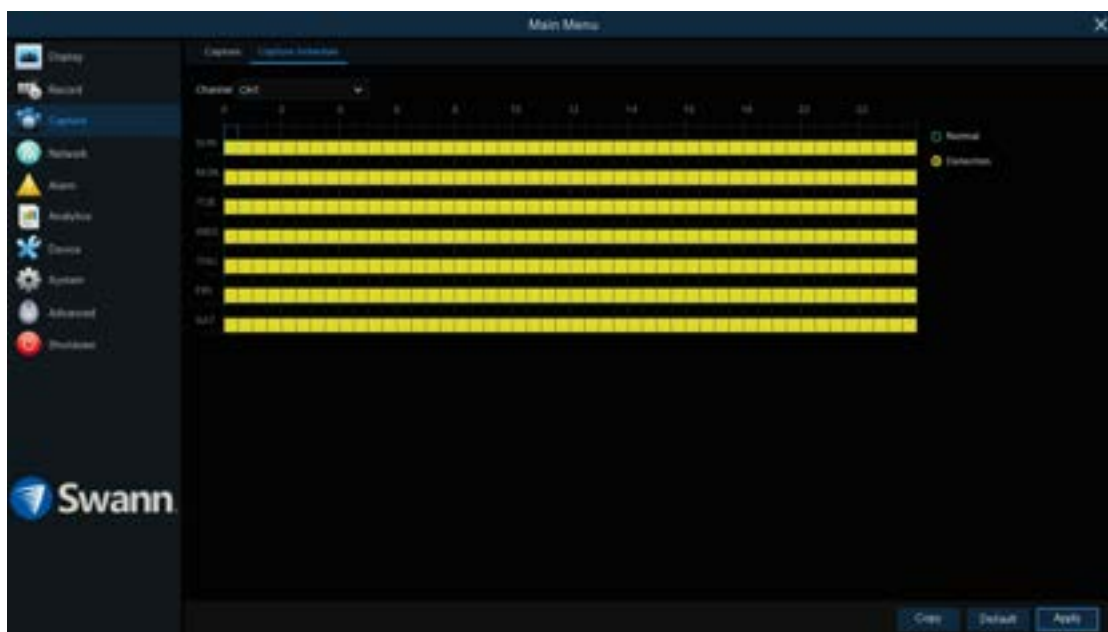

Like the analytic recording schedule, a capture schedule must be created so your DVR can take snapshots when an event has occurred or if you want to take snapshots using a time interval (every 5 seconds for example).

- Use the “Copy” function to apply all settings to the other cameras connected.
- Click “Default” to revert to default settings.
- Click “Apply” to save settings.

Channel: Select a camera that you would like to edit.

Normal: A snapshot will be taken according to the normal interval setting selected (every 5 seconds for example).

Detection: A snapshot will be taken each time motion has been detected according to the alarm interval selected.

Each square represents 30 minutes. Using the mouse, select the desired capture mode then click on a particular square to change or click and drag the mouse over the squares corresponding to your desired time period. The same action can also be applied if Normal or Detection capture mode is not required (on one or more sections that have been enabled).

Event Playback & Backup

The Search function gives you the ability to search for and play previously recorded videos as well as snapshots that are stored on your DVR's hard drive. You have the choice of playing video that matches your recording schedule, manual recordings, analytic events or motion events only. The Backup function gives you the ability to save important events (both video and snapshots) to a USB flash drive.

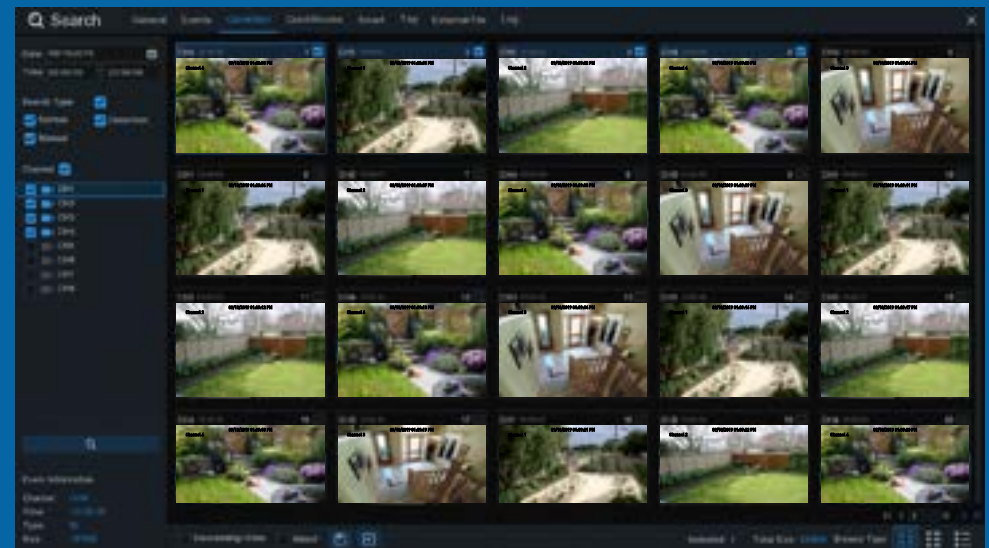
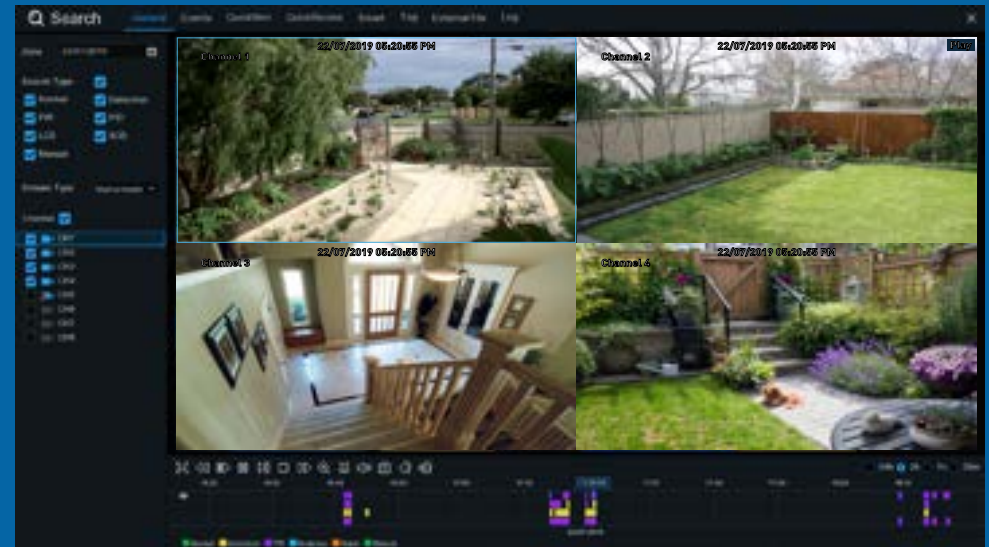

Search: General

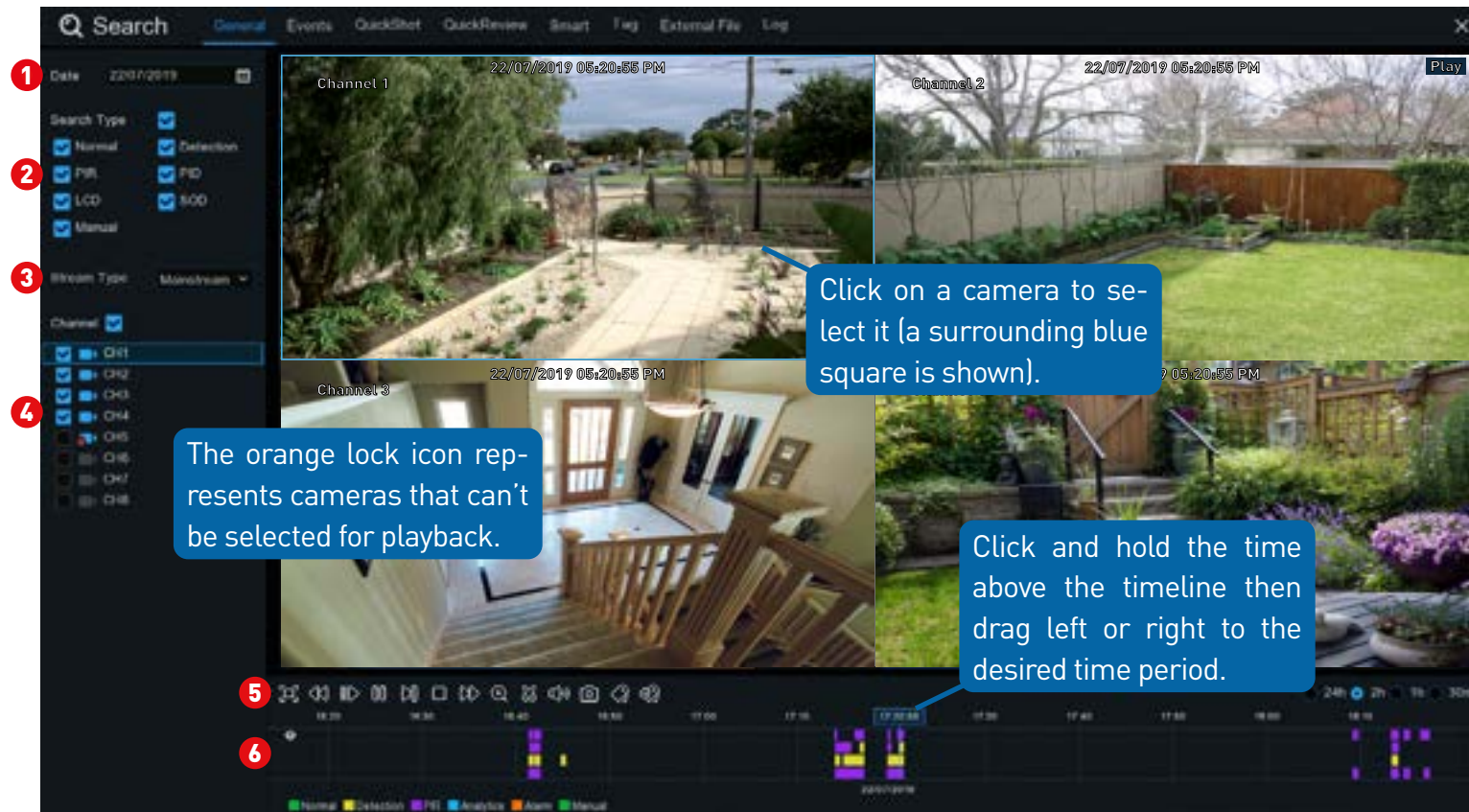

- 1 Click the calendar icon to select a date that you want to search on. A red underline on a date indicates there are recordings on those particular dates.
- 2 This is the event type that you can search for. In most circumstances "Detection" and or "PIR" would be selected but you can leave all event types enabled if you want to search for all. Adjust accordingly.
- 3 Select either Mainstream or Substream for playback (Mainstream will play video at the camera's native recording resolution).

- 4 Select from one or more cameras to display for playback (a maximum of four cameras can be selected for playback only). A blue camera indicates which cameras match your search criteria.
- 5 Click this to hide the playback interface so you can maximise your viewing area (watch full-screen). Right-click to restore.
- 6 Recordings that match your search criteria will be displayed here.

(continued on next page)

Search: General

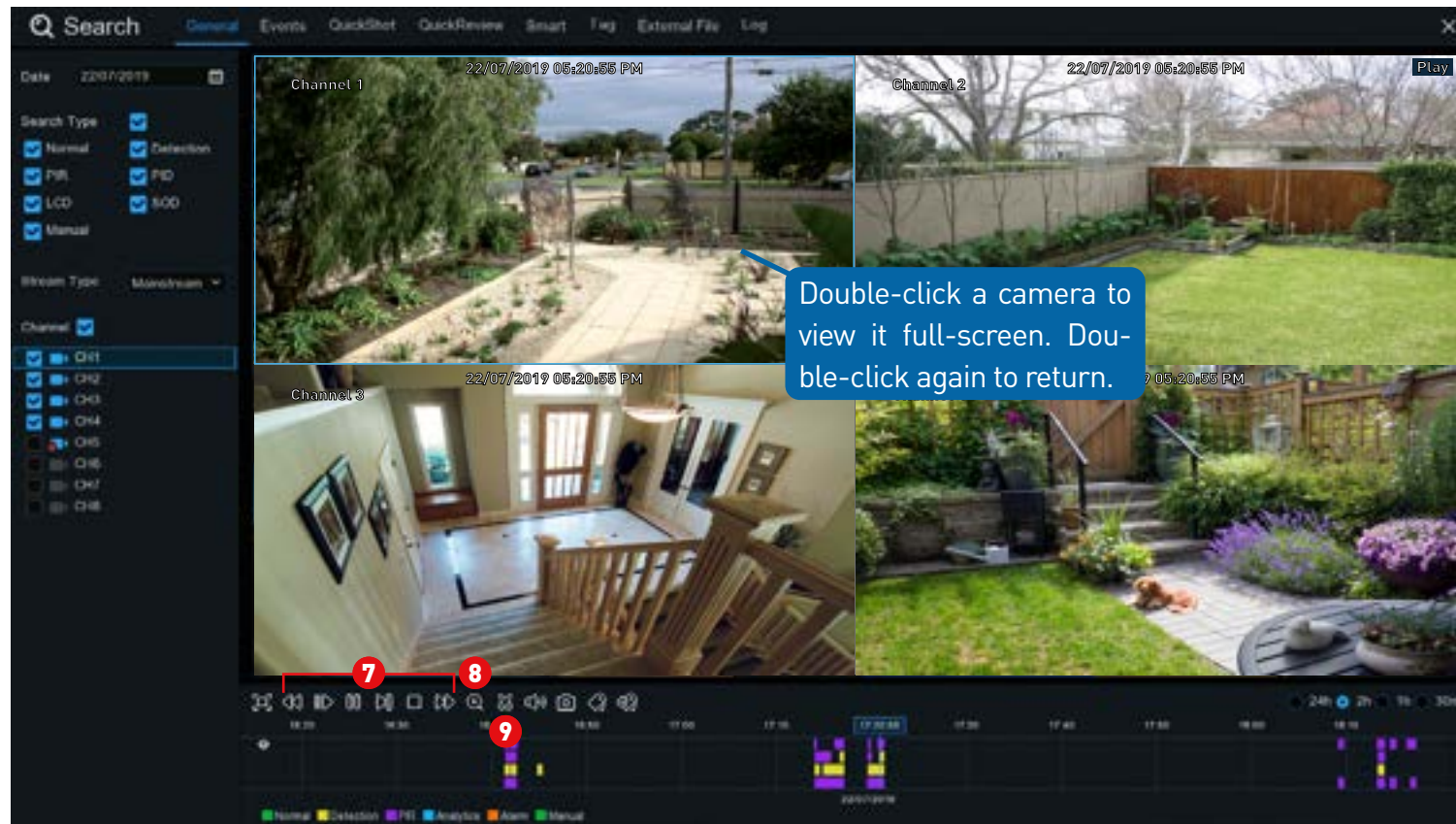

- 7** From left to right, these are your reverse, slow motion, play/pause, frame advance, stop and fast forward controls. Subsequent presses of the reverse, slow motion and fast forward buttons will increase the speed of each action.
- 8** Select a camera, click this button then use the scroll button on the mouse to zoom. Use the picture-in-picture screen to select a different area to view. Right-click to exit.
- 9** This button allows you to edit the video by setting mark in and mark out

points which you can then copy to a USB flash drive. Click on a camera to select it then press this button. You will see two white triangles on the timeline. Move them left or right on the section of video that you want to edit. Click the disk icon (Back-up) to save. For the backup type, leave the default selection (mp4) for wider playback compatibility on your computer. Insert a USB flash drive to your DVR then click "Save". Click "OK" to save then click "Close" when finished.

(continued on next page)

Search: General

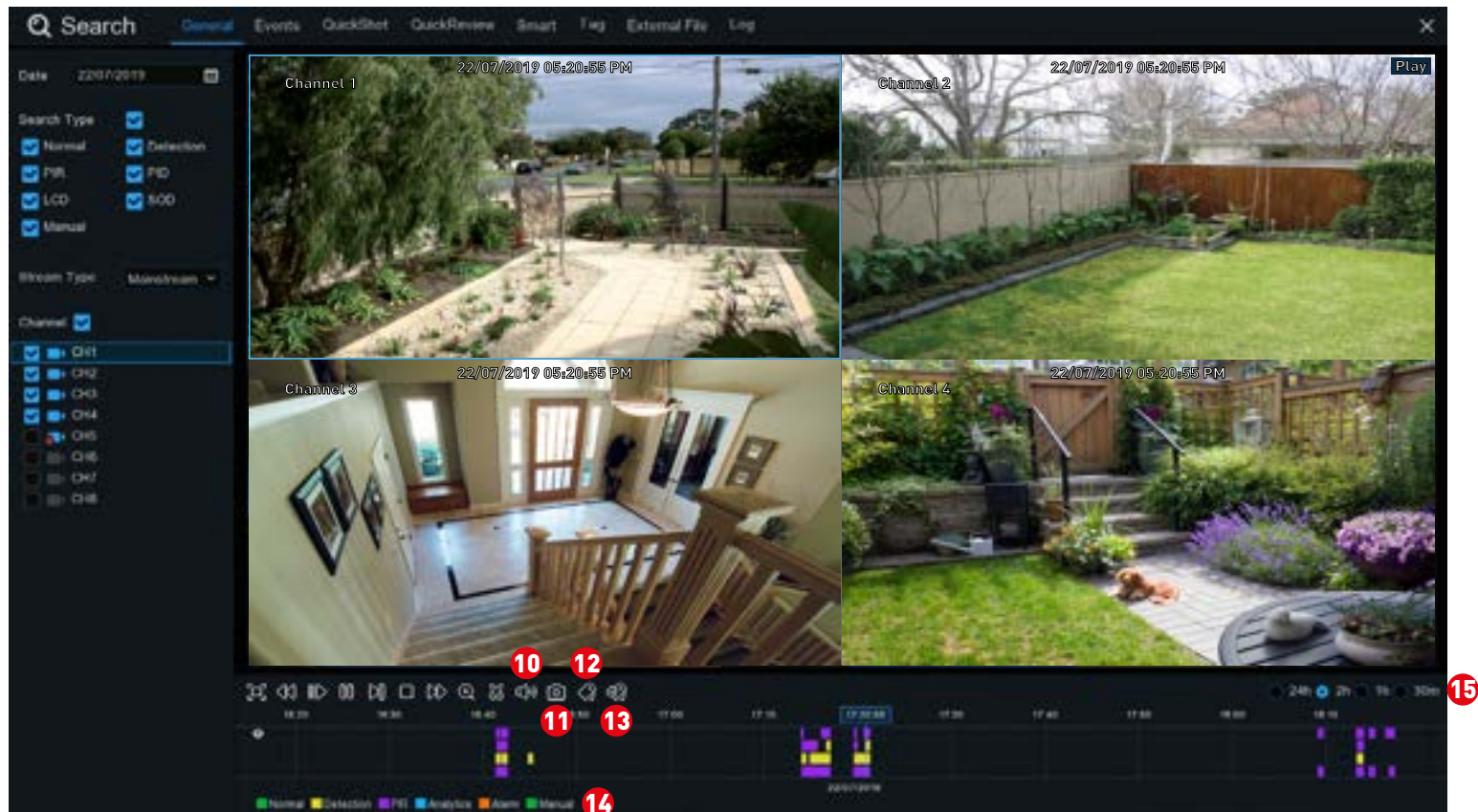

10 Click this button to mute or unmute the audio.

11 This button allows you to save a snapshot to a USB flash drive. Click on a camera to select it then press this button.

12 Tagging allows you to record information such as a person or object within the video. Click on a camera to select, pause the video when you see a person or object to be tagged then press this button (multiple tags can be created).

13 As above but you can choose your own tag name.

14 Indicates the video type on the timeline.

15 This represents the time period that is visible. Click on a different time period to zoom in for precise control or to zoom out.

To search for tags (see page 106 - [Search: Tag](#)).

Search: Events (copy events to a USB flash drive)

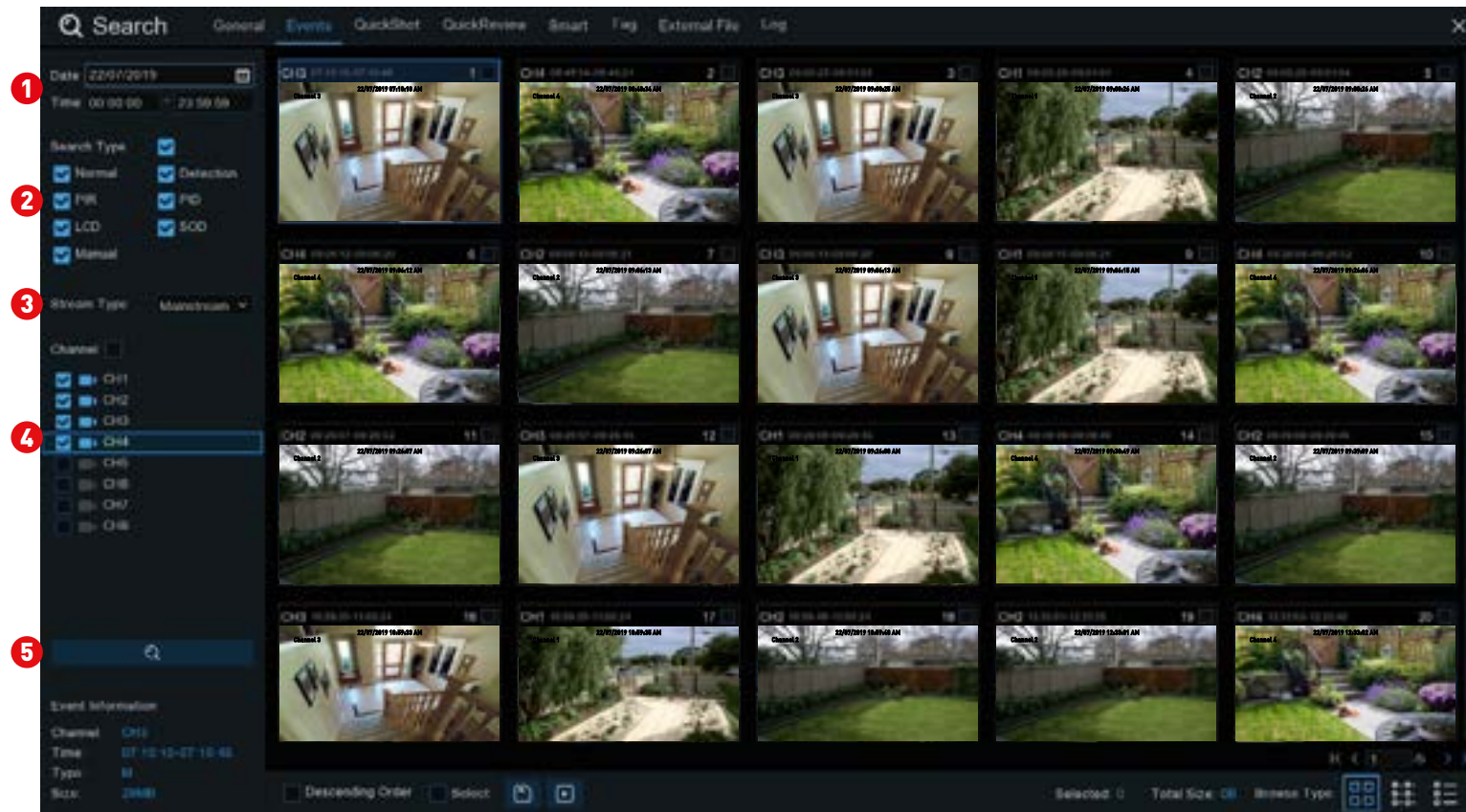

Use this function to search, play and copy events to a USB flash drive.

- 1 Click the calendar icon to select a date that you want to search on. A red underline on a date indicates there are recordings on those particular dates. For time, you can search over a 24 hour period or you can use the keypad to enter a specific start and end time.
- 2 This is the event type that you can search for. Adjust accordingly.
- 3 Select either Mainstream or Substream to search for (Mainstream will

play video at the camera's native recording resolution).

- 4 Select from one or all cameras that you would like to search on. A blue camera indicates which cameras match your search criteria.
- 5 Click this button to commence a search. You will see a thumbnail of each event that matches your search criteria. Click the checkbox above each thumbnail to select it.

(continued on next page)

Search: Events (copy events to a USB flash drive)

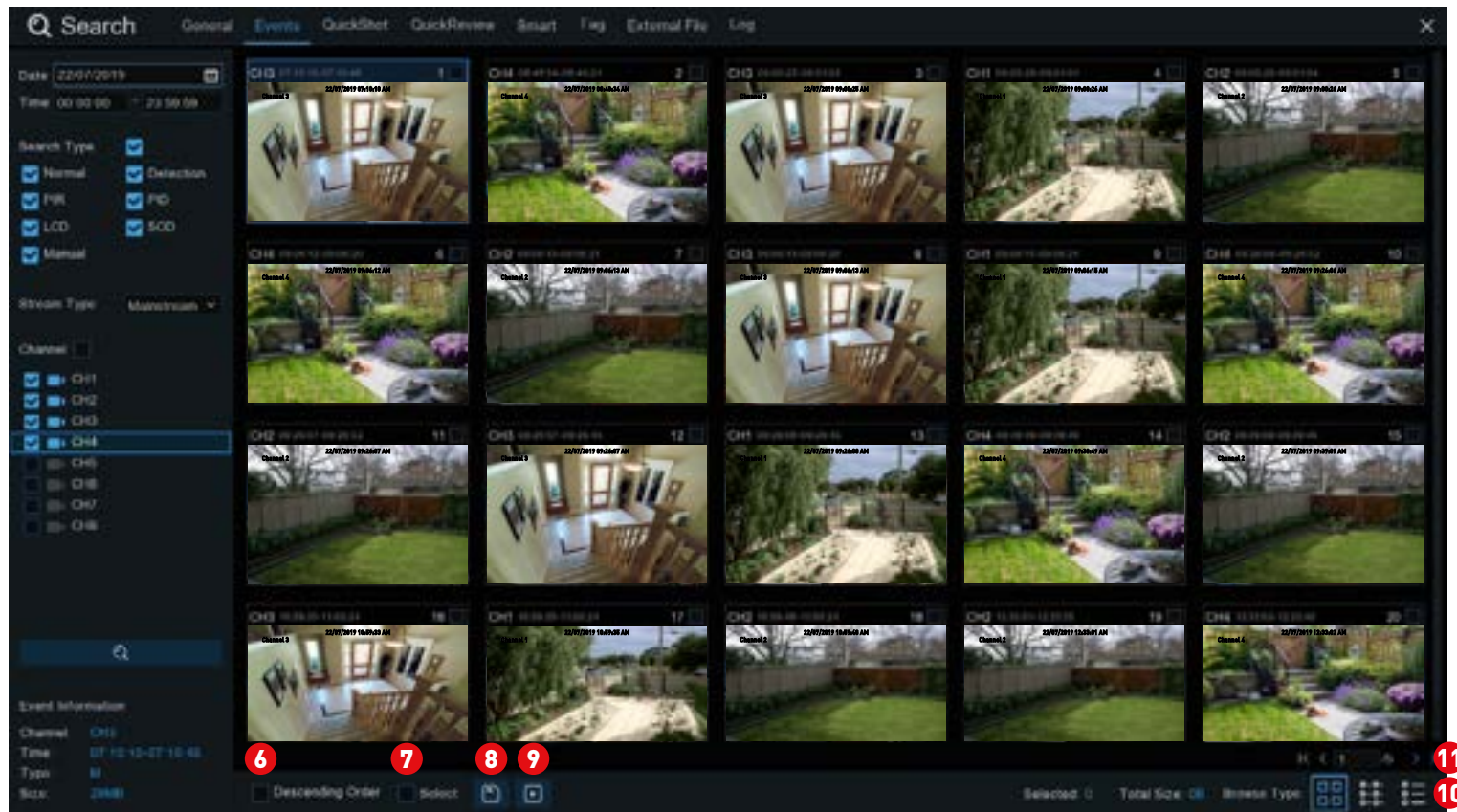

6 Click the checkbox to view the events in descending order.

7 Click the checkbox to select all events.

8 When one or more events have been selected, click this button to copy to a USB flash drive. For the backup type, leave the default selection (mp4) for wider playback compatibility on your computer. Insert a USB flash drive to your DVR then click “Save”. Click “OK” to save then click “Close” when finished.

9 Click this button to play a selected event. Right-click to exit.

10 Click these to change how the events are displayed. Default view is Thumbnail but you can change to List or Detail.

11 Click these to navigate to a different page available. Use the keypad to navigate to a specific page.

Search: QuickShot (copy snapshots to a USB flash drive)

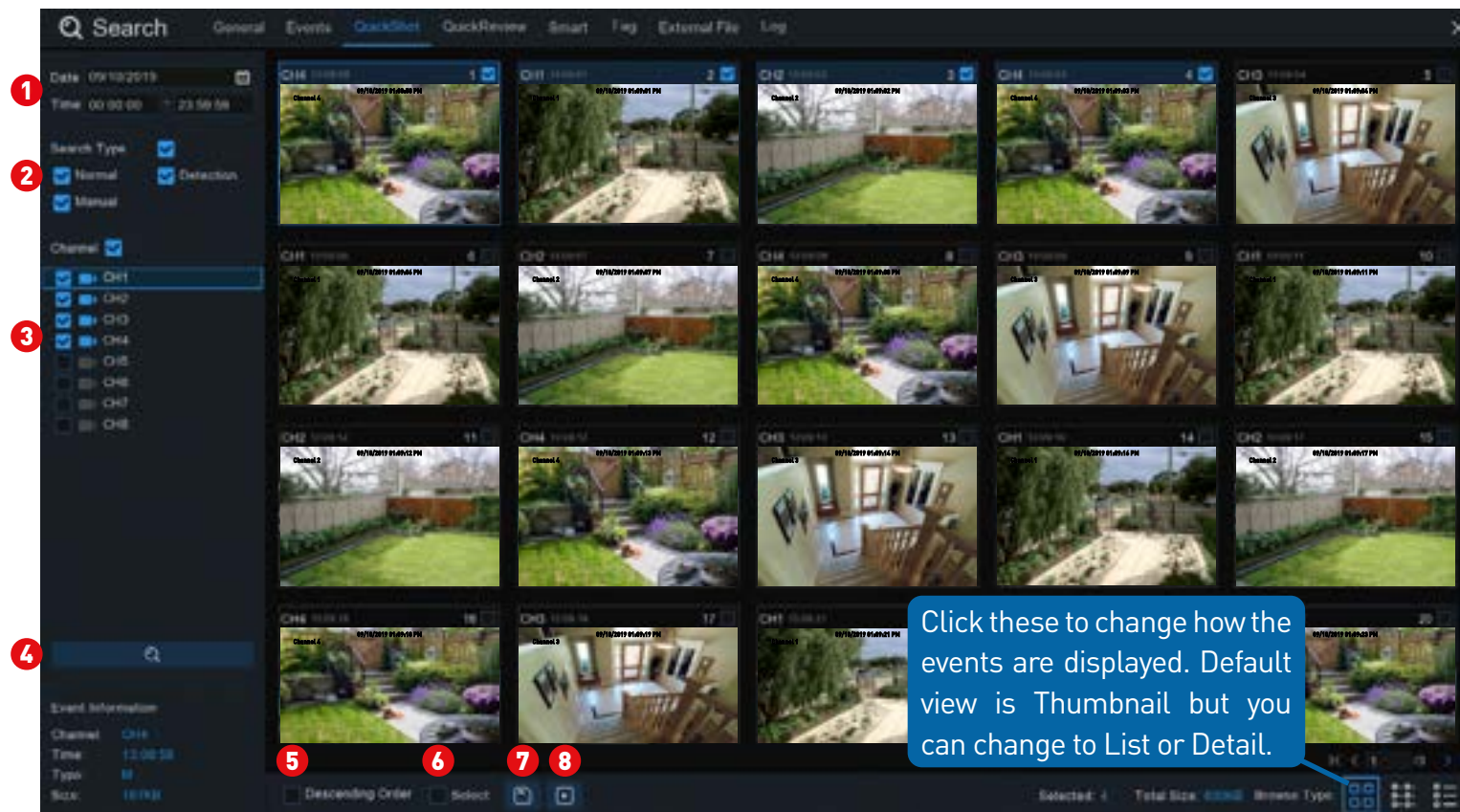

Use this function to search, play and copy snapshots to a USB flash drive.

- 1 Click the calendar icon to select a date that you want to search on. A red underline on a date indicates there are recordings on those particular dates. For time, you can search over a 24 hour period or you can use the keypad to enter a specific start and end time.
- 2 This is the event type that you can search for. Adjust accordingly.
- 3 Select from one or all cameras that you would like to search on.

- 4 Click this to commence a search. You will see a snapshot of each event that matches your search criteria.
- 5 Click the checkbox to view snapshots in descending order.
- 6 Click the checkbox to select all snapshots.
- 7 Select a snapshot then click this button to copy to a USB flash drive.
- 8 Click this to play a slideshow (see page 102 - [Playing a Slideshow](#)).

Playing a Slideshow

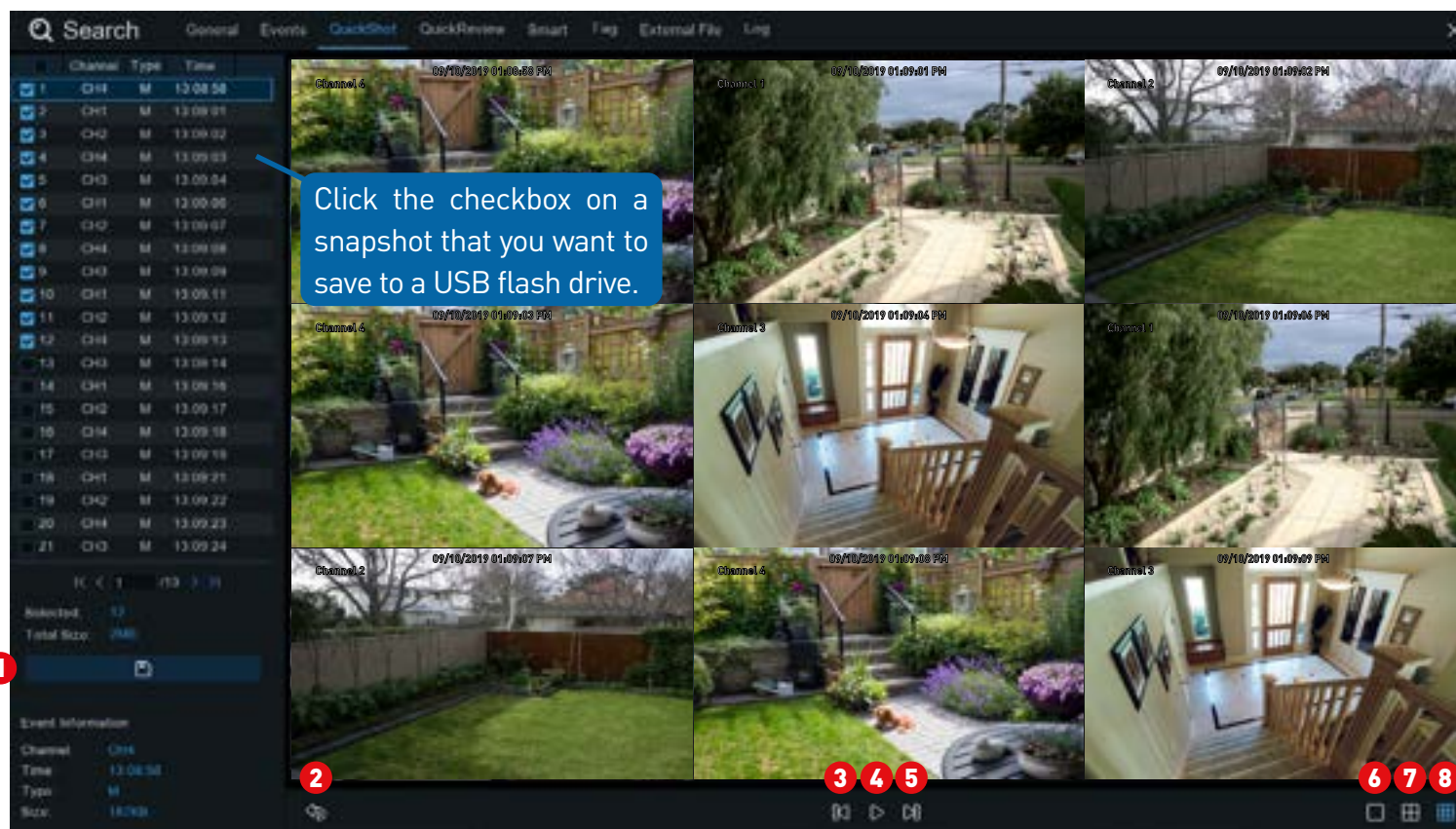

- 1 Select a snapshot then click this button to copy to a USB flash drive.
- 2 Click this to go back to the previous screen.
- 3 Click this to display the previous group of snapshots.
- 4 Click this to pause or play a slideshow.
- 5 Click this to display the next group of snapshots.
- 6 Click this to view a single snapshot at a time.

- 7 Click this to view four snapshots at a time.
- 8 Click this to view nine snapshots at a time.

Search: QuickReview

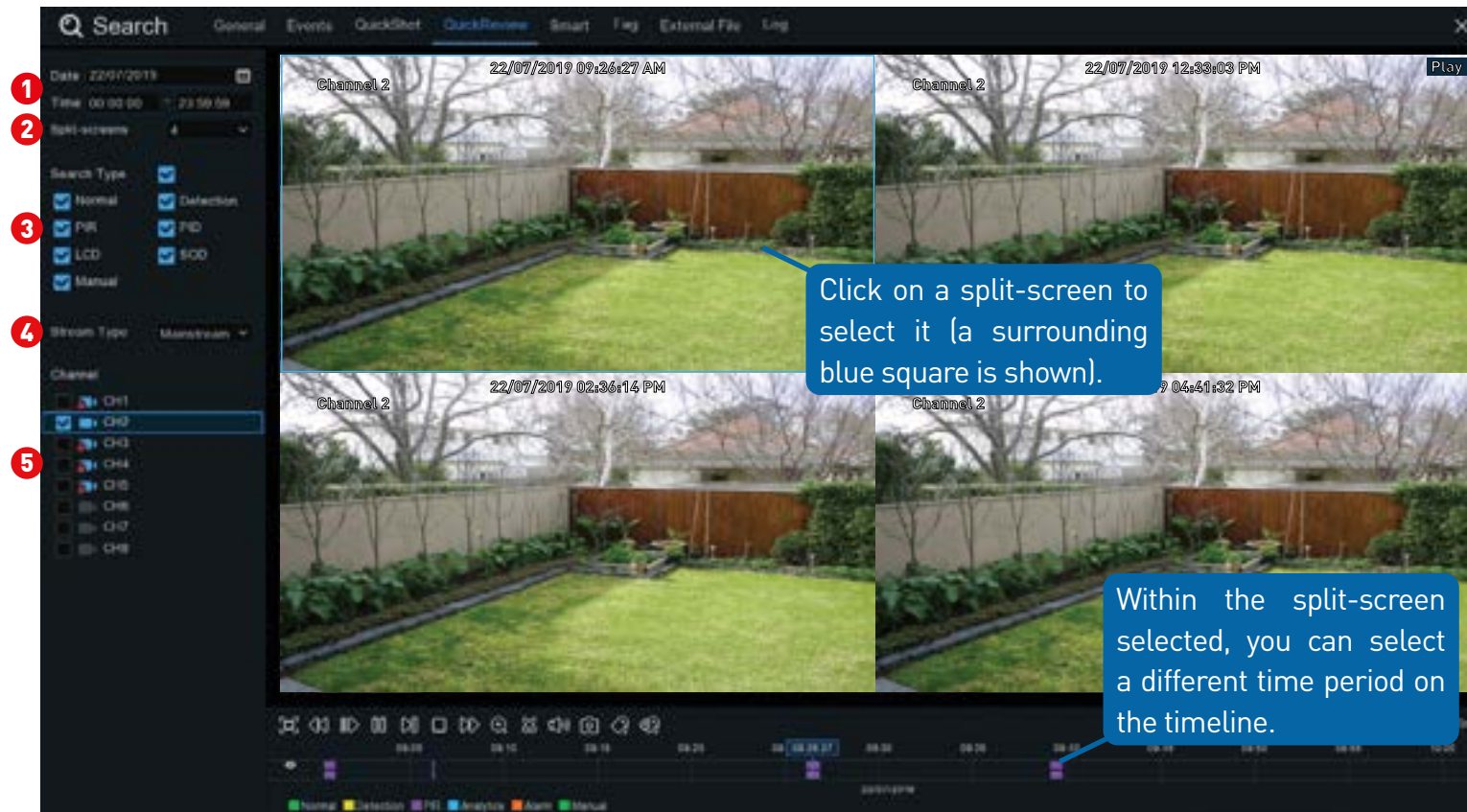

QuickReview allows you to play multiple normal recordings and motion events simultaneously from a single channel. With normal and event recordings, the video is divided evenly depending on the split-screen mode that has been selected. For example, if the video is an hour long and you have selected Split-screens x 2, each split-screen will play for 30 minutes.

1 Click the calendar icon to select a date that you want to search on. A red underline on a date indicates there are recordings on those particular dates. For time, you can search over a 24 hour period or you can use the keypad to

enter a specific start and end time.

- 2 Click the drop down menu to select the preferred split-screen mode.
- 3 This is the event type that you can search for. Adjust accordingly.
- 4 Select either Mainstream or Substream to search for.
- 5 Select the camera that you would like to search on.

See [page 96](#) for an explanation of the controls on the timeline.

Search: Smart



Smart mode allows you to define one or more specific areas of the video which then makes it easier to find what you are searching for. For example, you may have movement on the left-hand side of the yard, but you want to see what is happening on the right-hand side.

1 Click the calendar icon to select a date that you want to search on. A red underline on a date indicates there are recordings on those particular dates. For time, you can search over a 24 hour period or you can use the keypad to enter a specific start and end time.

2 This is the event type that you can search for. Adjust accordingly.

3 Select the camera that you would like to search on.

4 Click the "Play" button to play each event.

5 Click this button to enter Smart mode. The camera will be shown full screen and the Smart mode controls will be visible.

(continued on next page)

Search: Smart



- 6 Click this to define a full screen detection area.
- 7 Click this to delete all areas created.
- 8 Click this to search and play video based on the areas defined.
- 9 Click this to return to the playback interface.

To define one or more specific areas, please do the following:

- 10 Click and drag to select the area that you want to define. Multiple areas can be defined. You can also use the same action to remove sections of the defined area or to delete it entirely.
- 11 When finished, click the search button (magnifying glass) to play video based on the areas defined.

You'll be returned back to the playback interface. Segments matching your search criteria will be shown on the timeline in dark blue.



TIP

Can I use Smart mode on multiple cameras at the same time? Due to the complexities and processing power required, you can only use Smart mode on one camera at a time.

Search: Tag

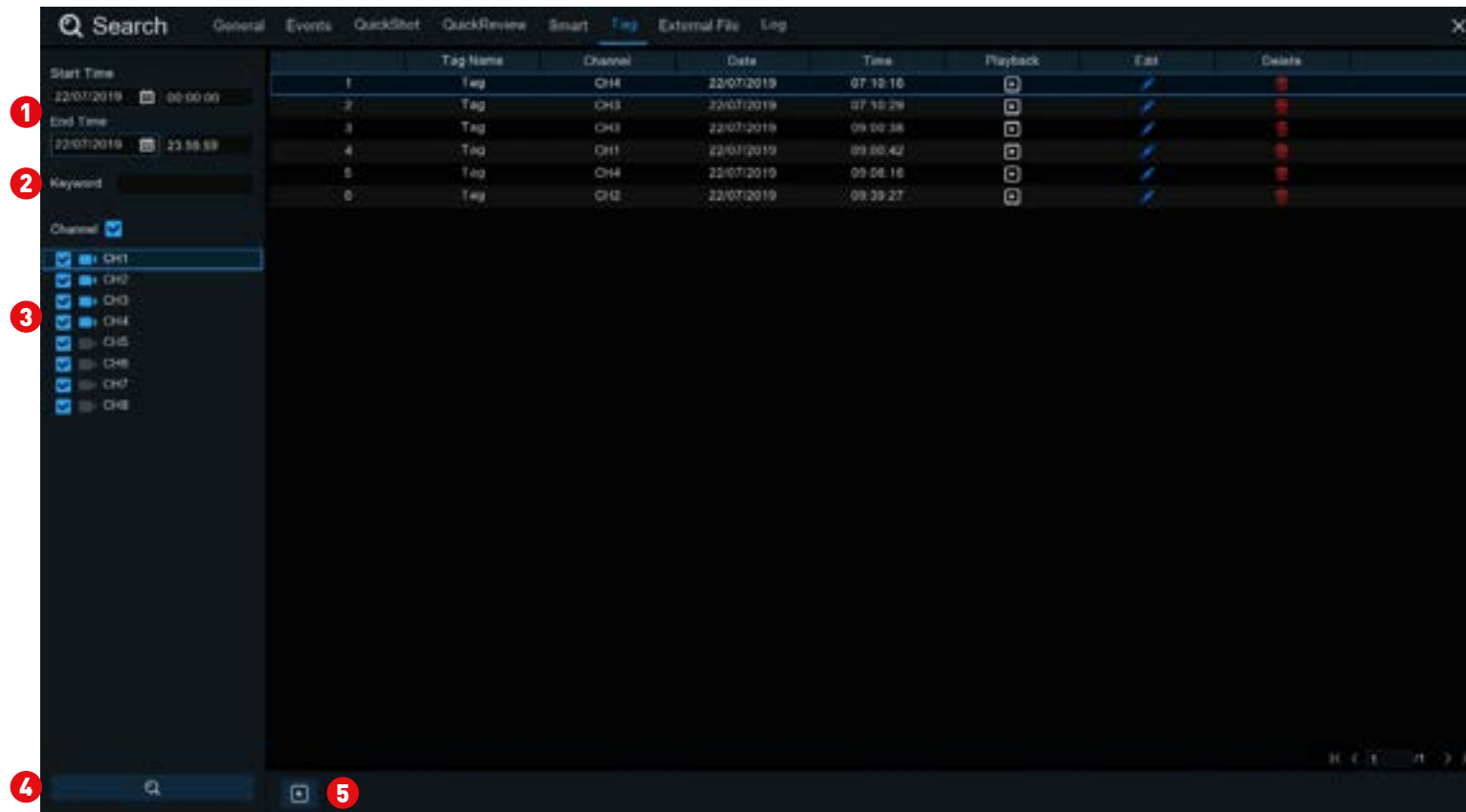

- 1 Click the calendar icon to select a date that you want to search on. For time, you can search over a 24 hour period or you can use the keypad to enter a specific start and end time.
- 2 If you have created one or more customized tags, click this to input the tag name (tag names are case sensitive).
- 3 Select the camera that you would like to search on.
- 4 Click this button to commence a search. Tags matching your search cri-

teria will be displayed.

- 5 Select an event then click this to play or double-click an event to play.

Edit: Click this to edit the tag name.

Delete: Click this to delete the tag.

See [page 96](#) for an explanation of the controls on the timeline.

Search: External File

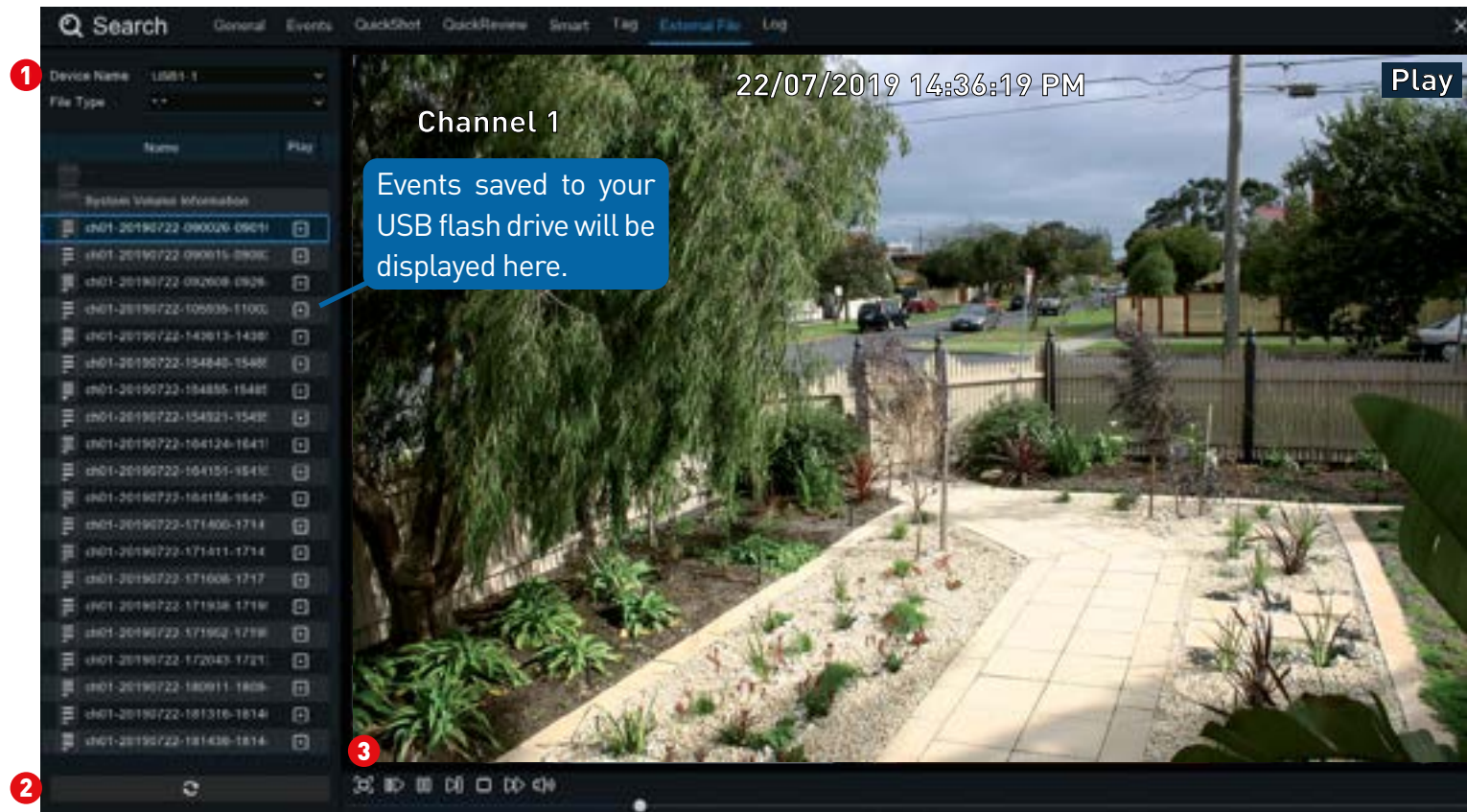

Use this function to play events that you have copied to a USB flash drive.

1 If multiple USB flash drives are connected, click the drop down menu to select the drive that you want to read from.

2 Click this button to refresh the USB flash drive.

Double-click an event to play.

3 Click this to hide the playback interface so you can maximise your viewing area. Right-click to restore.

System Configuration

The options available give you complete control on how your DVR is configured and how it operates. Some of the options such as display resolution, time zone, email configuration, Daylight Saving and password creation are configured during the Startup Wizard. For experienced network users, your DVR provides options that can be configured to suit your particular requirements. You can also perform a firmware upgrade when available.

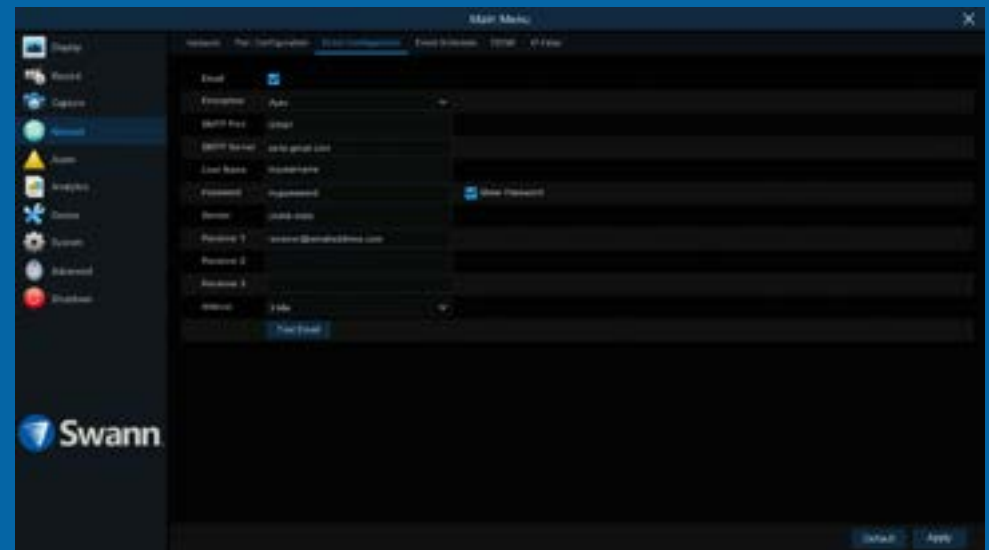
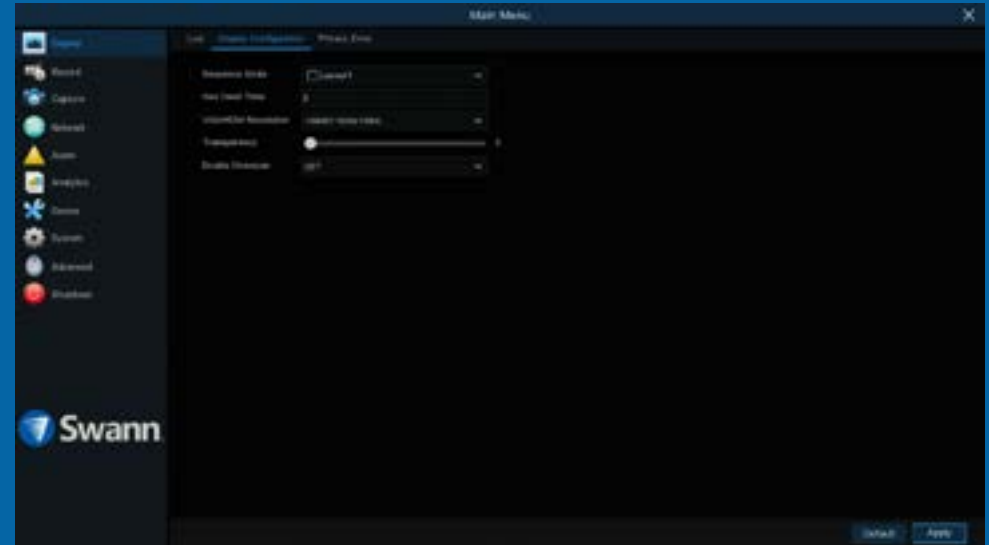

Display: Display Configuration

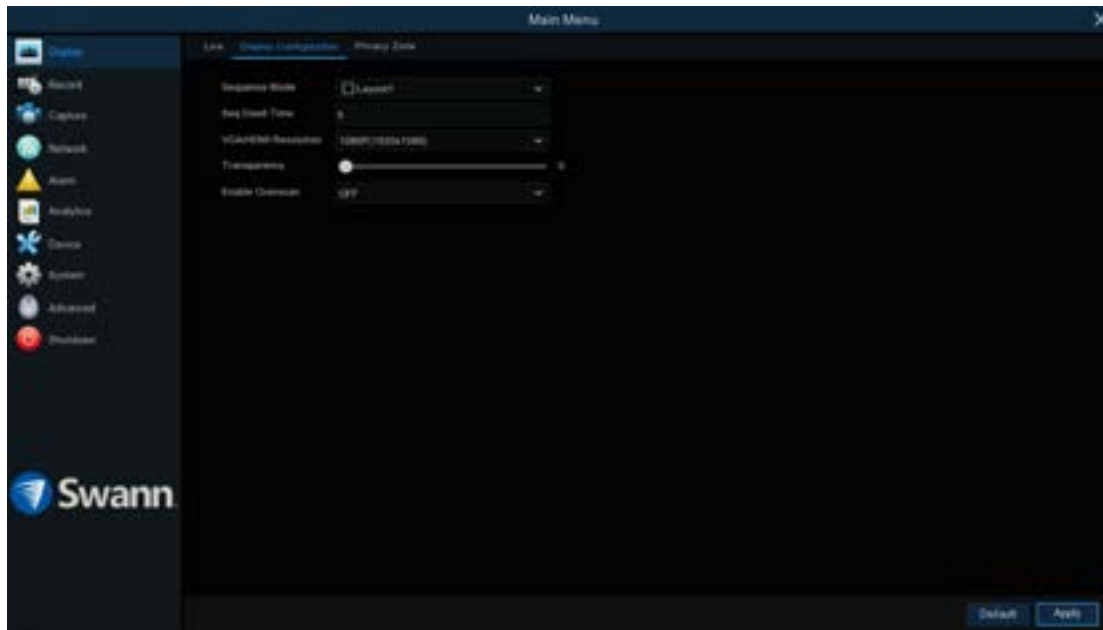

- Click “Default” to revert to default settings.
- Click “Apply” to save settings.

Sequence Mode: Select how many video channels you would like to display when your DVR is in sequence mode. You can select from one, four or six cameras to display at a time.

Sequence Dwell Time: Enter in seconds the maximum length of time you would like to display a video channel in sequence mode before displaying the next video channel (300 seconds is the maximum).

VGA/HDMI Resolution: Select a display resolution that is suitable for your TV.

Transparency: Click and hold the slider left or right to change how transparent the Menu Bar and Main Menu will appear on-screen. Adjust accordingly.

Enable Overscan: Is mainly used on older television sets to display the entire viewable area correctly on-screen. It does this by cutting off the edges of the picture. This is not required for modern Plasma and LCD TVs as the image is

digitally processed to display the correct aspect ratio.

Network: Network

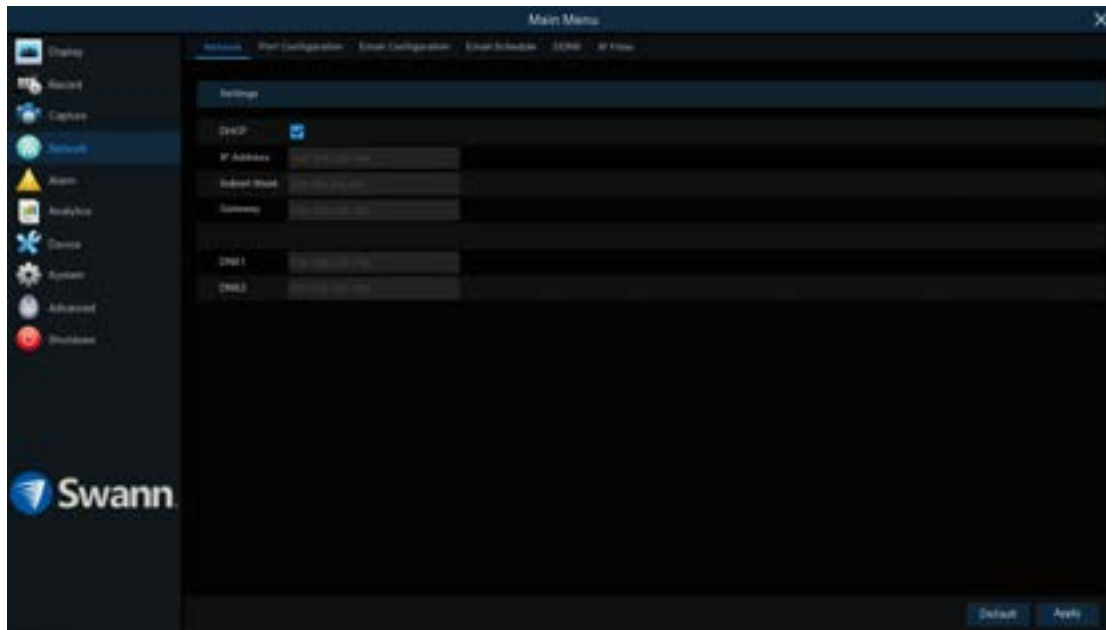

As SwannLink Peer-to-Peer technology is utilised to communicate with your network and mobile device, configuration of the network settings is not required. If you have networking expertise and require specific settings, you do have the ability to change them.

- Click “Default” to revert to default settings.
- Click “Apply” to save settings.

DHCP (Dynamic Host Configuration Protocol): Your router will automatically assign an IP address to each device connected to your network. This is enabled by default and is the recommended method of connection.

If you are disabling DHCP, the following five options can be changed (this is for advanced users only):

IP Address: Each device on your network must have a unique IP address. A typical address might be “192.168.1.24” or something similar.

Subnet Mask: This allows the flow of network traffic between hosts to be segregated based on a network configuration. A typical address might be “255.255.255.0” or something similar.

Gateway: This allows your DVR to connect to the internet. This is typically the same IP address as your modem or router.

DNS (Domain Name System)1/2: Input the DNS settings for your internet service provider.

Network: Wi-Fi

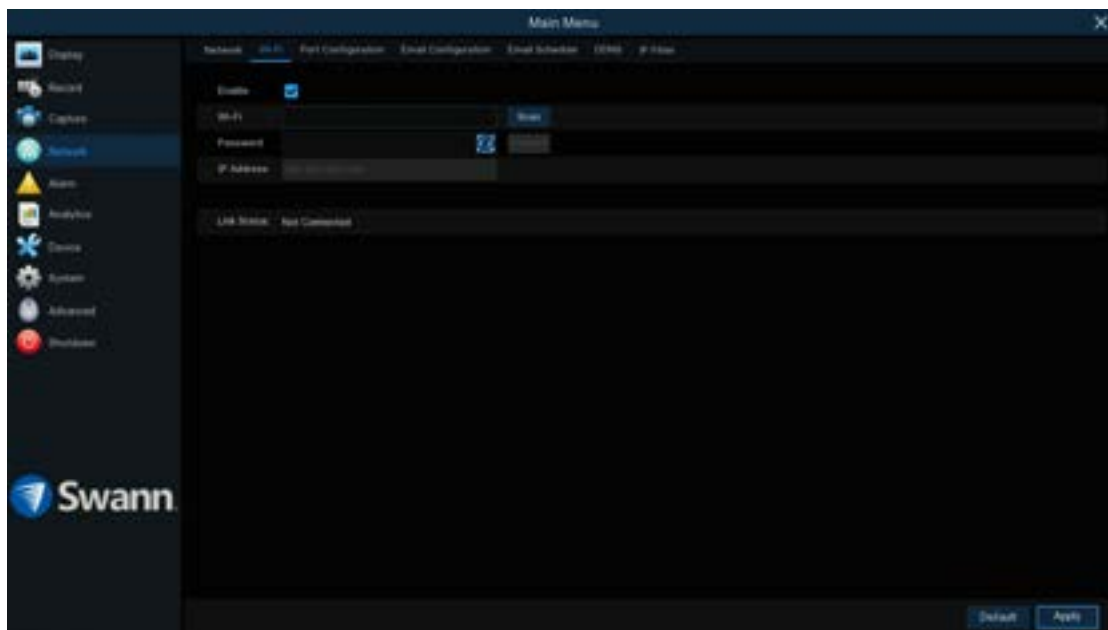

If you have a compatible Wi-Fi dongle connected to an available USB port on your DVR, the Wi-Fi tab will appear. This gives you the flexibility of placing your DVR in a different location, without having to be physically connected to your router or modem.

- Click “Default” to revert to default settings.
- Click “Apply” to save settings.

Before proceeding, disconnect the Ethernet cable from your DVR’s Ethernet port (if connected).

1. Click the “Scan” button. After a short moment, a list of Wi-Fi access points that your DVR detects, will be shown. Select your Wi-Fi access point then click the “Save” button.

2. Input the password for your Wi-Fi access point then click the “Connect” button. Make sure the password is correct before proceeding (click the eye icon to display the Wi-Fi password).

3. After a short moment, your DVR will connect to your Wi-Fi access point. Click “OK” to continue (if the connection has failed, check that the password is correct).

The Link Status will change to Connected indicating a successful connection.

Click “Apply” to save settings.

If the Wi-Fi dongle needs to be removed, click the “USB Wi-Fi” button on the Menu Bar (next to the date & time), then click “Safely remove USB Devices”. Remove the Wi-Fi dongle then click “OK”.

Network: Port Configuration & RTSP

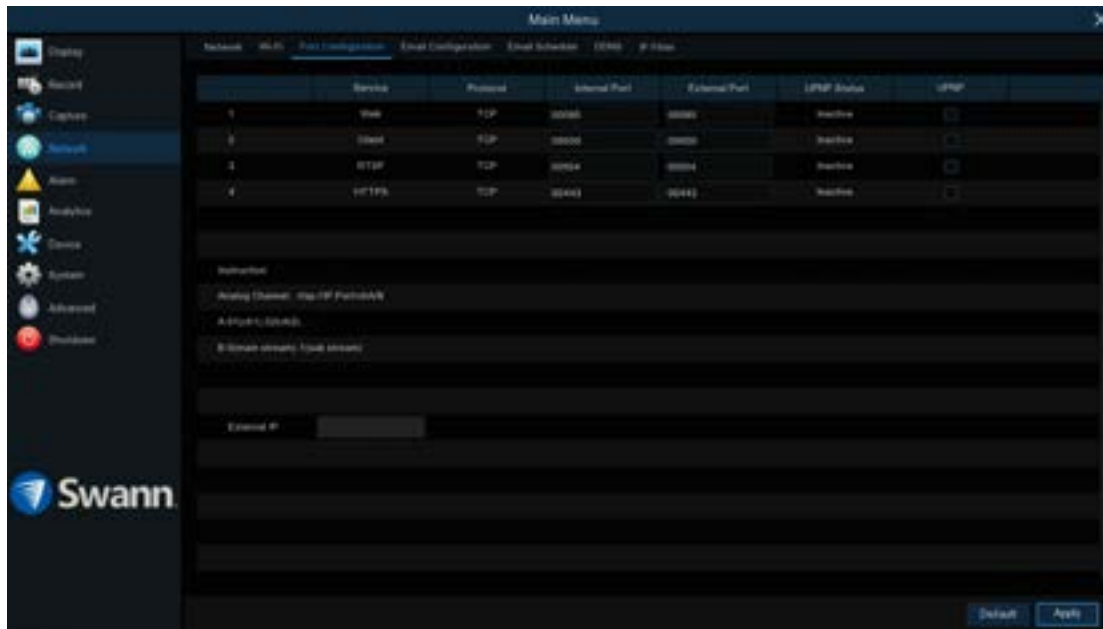

- Click “Default” to revert to default settings.
- Click “Apply” to save settings.

The cog symbol (top right) indicates functions that are suitable for experienced users and/or some networking knowledge is required.

In most circumstances there is no need to change the settings here. The following is for advanced users only.

Web: This port is used to log into your DVR via your network or remotely. The default port number (85) is seldom used by other devices, however if you have another device using this port, you may need to change it. An alternative port number to use is 90.

Client: This is the internal port that your DVR will use to send information through. This particular port number (9000) is not used by many devices, however if you have another DVR-like device, you may need to change it

RTSP: This port can be used to stream a camera’s live view image to your computer, using video streaming software such as VLC media player (see page 113 - [Using RTSP](#) for more information).

HTTPS: Basically the same as HTTP Port but with an additional layer of security. The default port number (443) is seldom used by other devices.

UPNP: A network protocol designed to allow network connected devices to automatically configure the router for the purposes of remote access. Click the checkbox to enable (not required to be enabled when using UID).

Using RTSP

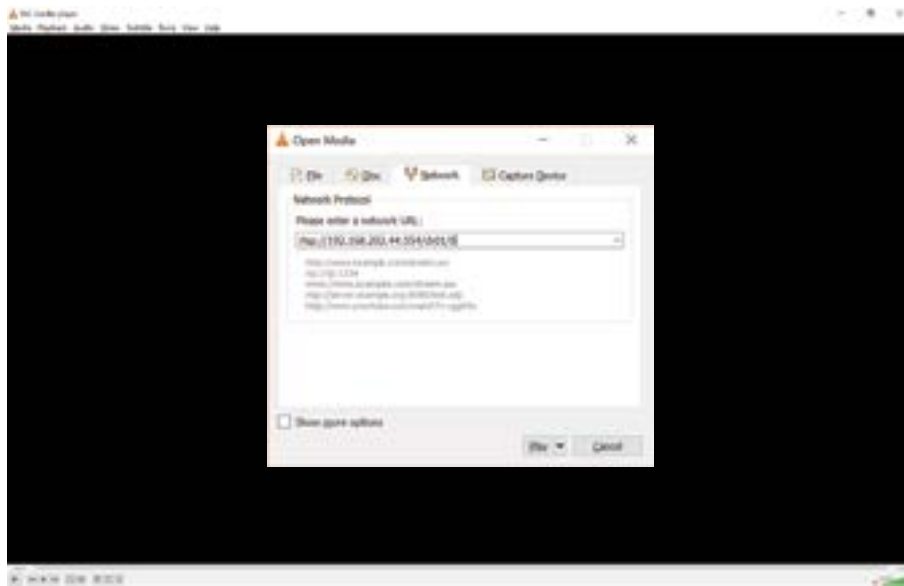

The following instructions are for the VLC media player software (you can download a free copy from www.videolan.org). After download, double click the file then follow the on-screen instructions for installation.

1. On your computer, load the VLC media player software. Click “Media” then click “Open Network Stream” (as shown on the left).

2. Enter the IP address of your DVR (on your DVR click “Network” in the Main Menu to display the IP address) into VLC. The following is an example of what you need to enter - `rtsp://192.168.202.44:554/ch01/0`.

rtsp://192.168.202.44: This is the IP address of your DVR.

554: This is the RTSP port of your DVR.

ch01: This represents channel 1. To display channel 2 enter ch02, etc.

0: This represents Mainstream. For Substream enter 1 instead.

3. Click “Play” then enter the user name and password. You will now see a live view image from the camera.



Network: Email Configuration

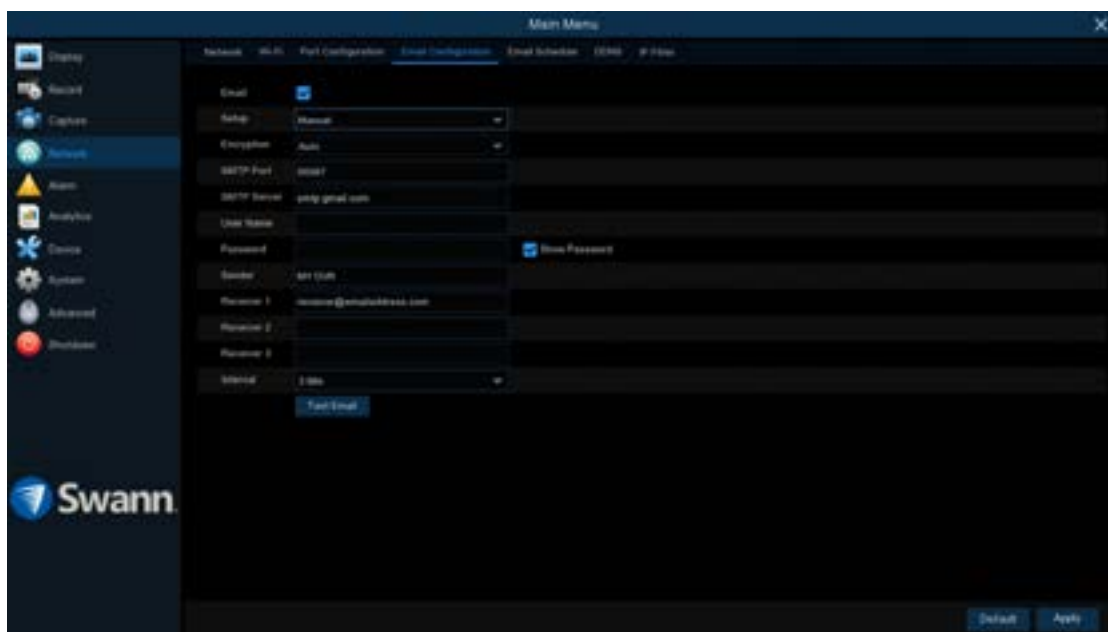

Why do I need to create an email for my DVR?

Inputting an email address is a requirement in the Startup Wizard. This is so your DVR can send you email alerts and to send you a password reset request if you have forgotten your password. Both Gmail and Outlook are supported. You can also use the email from your service provider, providing you know the settings to be used.

- Click “Default” to revert to default settings.
- Click “Apply” to save settings.

Email: Leave this enabled to receive email alerts.

Setup: Click the drop down menu and select “Manual” to enter your email details.

Encryption: Leave this on “Auto” to ensure your DVR will always use the correct encryption for your email provider.

SMTP Port: For both Gmail and Outlook, input 00587.

SMTP Server: Gmail input “smtp.gmail.com”. Outlook input “smtp.live.com”.

User Name: Input the email user name for your account.

Password: Input the email password for your account. Click the “Show Password” checkbox if you would like to hide your password.

Sender: Input a name for your email account, for example MY DVR.

Receiver 1/2/3: Input the email address(es) to send email alerts to.

Interval: This is the length of time that must elapse after your DVR sends an email alert before it will send another. Adjust accordingly.

Test Email: Click to verify the information is correct then click “OK”. A message will appear if the test has been successful. Click “OK” to continue.

Email not working? Please try the following:

1. Check that your email user name and password are correct.
2. Located at the back of your DVR, you should see one or two flashing LEDs (above the Ethernet port). If you don't see this, disconnect then reconnect the Ethernet cable or try a different port on your modem or router.
3. Search “less secure apps” at support.swann.com (if using Gmail).

Network: Email Schedule

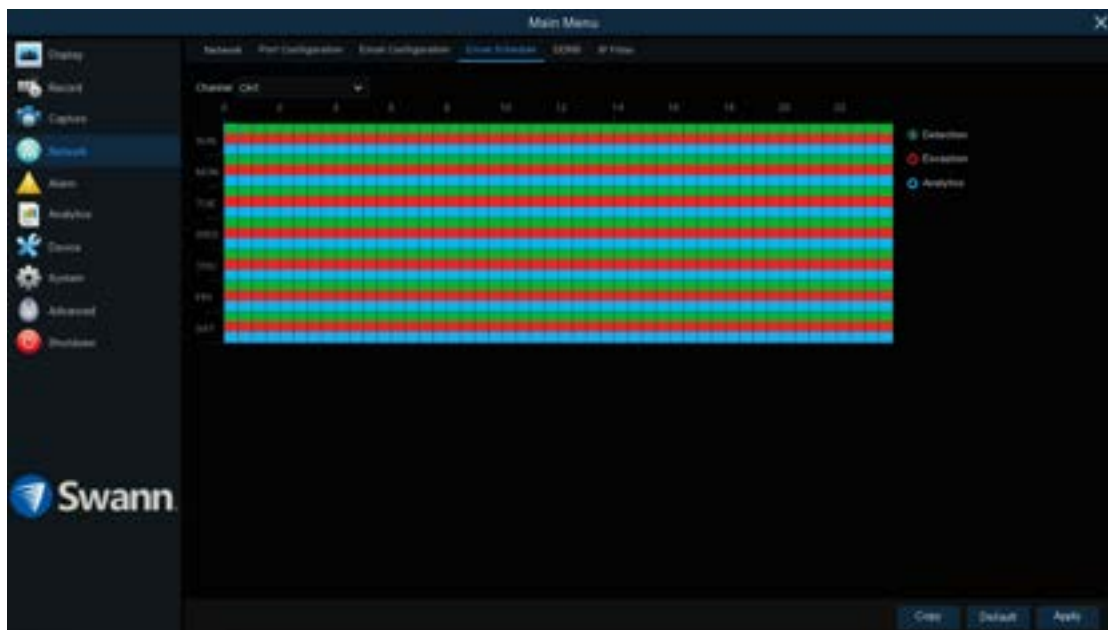

- Use the “Copy” function to apply all settings to the other cameras connected.
- Click “Default” to revert to default settings.
- Click “Apply” to save settings.

Channel: Select a camera that you would like to edit.

Detection: If email alerts have been enabled for motion detection, you can change the schedule on when your DVR can send those alerts. For example, you may only want to receive alerts during the day but not in the evening. A different schedule can be created for each camera.

Exception: There are three event types that your DVR will detect as an exception - no space left on the hard drive, a hard drive error and if one or more channels has lost the feed from its camera (see page 125 - [Advanced: Events](#)). It's recommended to leave the default schedule in place in case there is an exception that you need to be alerted to.

Analytics: If any of the analytic functions have been enabled, an email alert will automatically be sent when motion has been detected. A different sched-

ule can be created for each camera.

Each square represents 30 minutes. Using the mouse, click on a particular square to change or click and drag the mouse over the squares corresponding to your desired time period.

Network: DDNS

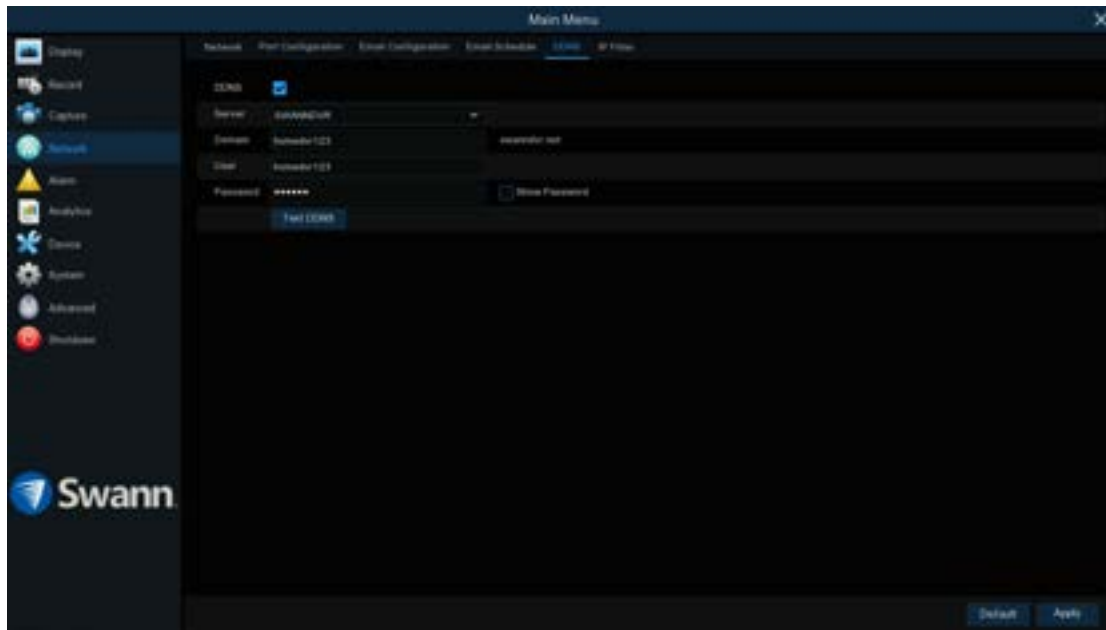

Prior to developing our SwannLink Peer-to-Peer technology, our SwannDNS service was used to connect to your DVR remotely. This service is still active and we recommend creating an account as a means of backup.

- Click “Default” to revert to default settings.
- Click “Apply” to save settings.

Go to www.swanndvr.com and click the “Registration” button. Follow the prompts to create your account.

DDNS: Click the checkbox to enable.

Server: SWANNDVR is automatically selected.

Domain: Enter the domain name that is hosted on your account. For example - (username.swanndvr.net).

User: Enter the username (host name) for your account.

Password: Enter the password for your account.

Test DDNS: Click this button then click “OK” to confirm your account details. After a short moment you will see “DDNS test is successful!”. Click “OK” to close.

Network: IP Filter

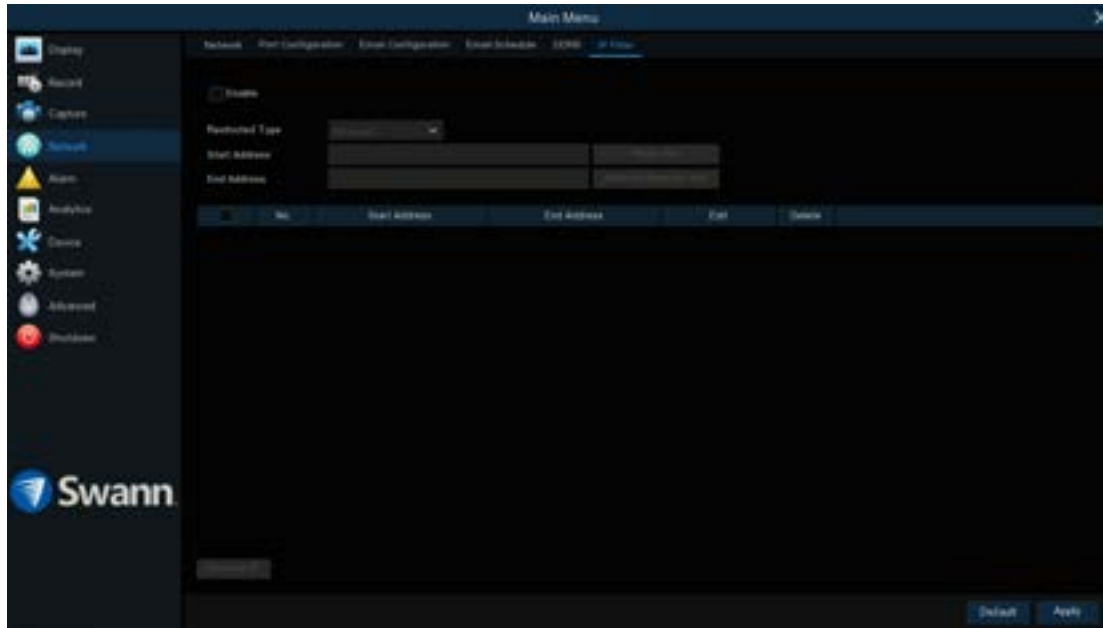

- Click “Default” to revert to default settings.
- Click “Apply” to save settings.

IP Filtering is a great way to limit access to your network devices for specific groups of IP addresses. For example, if you had a malicious user attacking your network, you could add a filter to prevent access to your devices from a single IP address or from a block of IP addresses. For the day-to-day function of your DVR, this function is not required.

Device: HDD

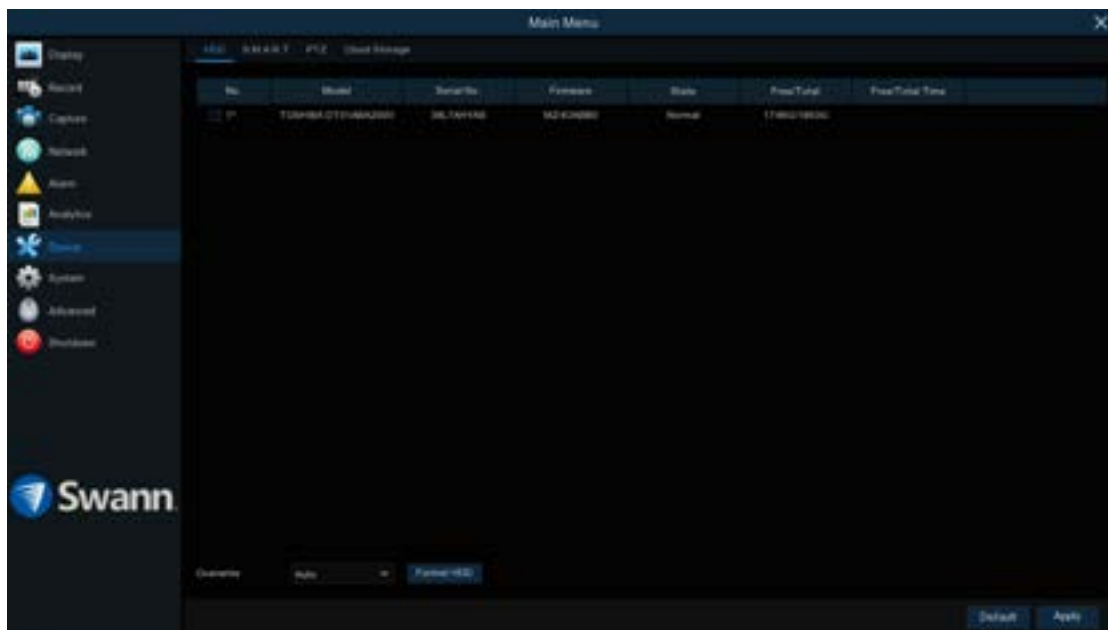

This function gives you the option of formatting your DVR's hard drive, and it will be listed here for selection (if a new hard drive has been installed inside your DVR, you need to format the drive before it can be used).

- Click "Default" to revert to default settings.
- Click "Apply" to save settings.

Overwrite: This instructs your DVR to overwrite the oldest video files as the hard drive becomes full. You also have the option of disabling this or selecting the amount of days events are kept before they are overwritten. It's recommended to leave the default selection as this prevents your DVR from running out of storage space.

Format HDD: Click the checkbox to select the hard drive then click this button to format. A message will appear noting that all data will be erased. Click "OK" to continue.



TIP

From time to time, we recommend that you format the hard drive. This ensures that your DVR maintains system integrity. Connect a USB flash drive to copy events that you want to save. Remember, formatting the hard drive erases all your recordings.

Device: S.M.A.R.T

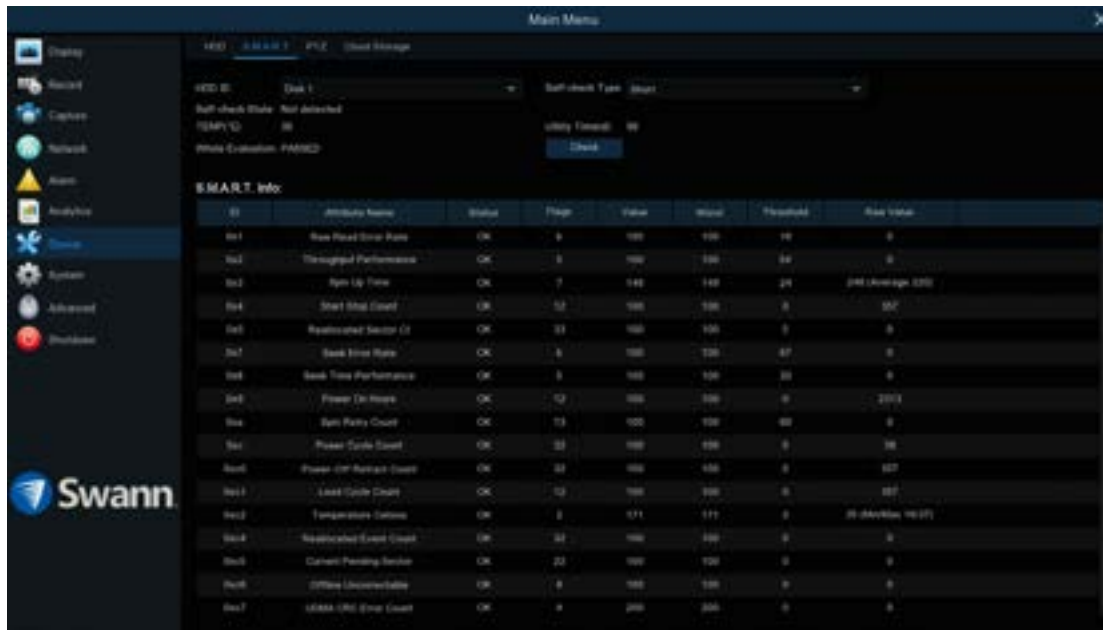

This function can be used to display technical information on the hard drive installed inside your DVR. You can also perform a test (there are three types available) to evaluate and detect potential drive errors.

Self-check Type: There are three types available:

Short: This test verifies major components of the hard drive such as read/write heads, electronics and internal memory.

Long: This is a longer test that verifies the above as well as performing a surface scan to reveal problematic areas (if any) and forces bad sector relocation.

Conveyance: This is a very quick test that verifies the mechanical parts of the hard drive are working.

When performing a test, your DVR will continue to work as normal.

In most circumstances, the information here will not be needed for general use of your DVR, however one of our Swann Helpdesk & Technical Support

staff may ask you to access this if you call for assistance.

Right-click the mouse to exit.

Device: Cloud Storage

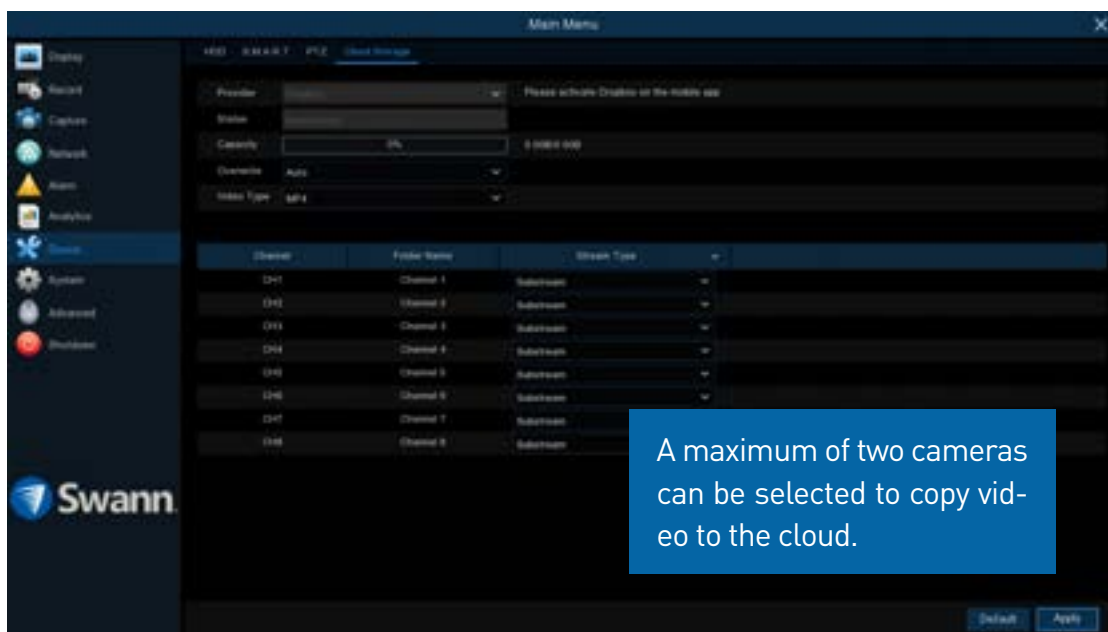

Your DVR has the ability to copy snapshots and video recordings to the cloud via Dropbox™. Dropbox™ is a service that allows you to store and share snapshots and video recordings and always have them on hand when needed.

- Click “Default” to revert to default settings.
- Click “Apply” to save settings.

A maximum of two cameras can be selected to copy video to the cloud.

Before activation, we recommend that you create a Dropbox account first. Go to www.dropbox.com, input your name, email address and password, agree to the terms & conditions then click or tap the sign up button. If you already have a Dropbox account you can skip this step.

Provider: Dropbox is the sole file hosting service and cannot be changed. To activate the cloud function, please use the Swann Security mobile app.

Status: This will change to Activated when active.

Capacity: When activated, this will display how much free space you have on your Dropbox account.

Overwrite: The default setting will overwrite the oldest files first. Click the drop down menu if you would like to select a particular time period instead.

Video Type: Leave the default selection for wider playback compatibility.

Stream Type: Click the drop down menu if you would like to select Substream (reduced quality) or Mainstream (high quality) video to be copied to the cloud.

To activate the cloud function:

1. In the Swann Security app, tap the “Menu” button (top left).
2. Tap “Dropbox”. A message will appear. Tap “Authorize”.
3. Input your login email address and password then tap “Sign in”.
4. Tap “Allow” then tap your DVR shown. A blue tick will appear next to your DVR. Tap “Done” to exit.
5. With the cloud function enabled, you need to instruct your DVR to send alerts to the cloud (see page 29 - [Alarm: Detection - Actions](#)).

System: General

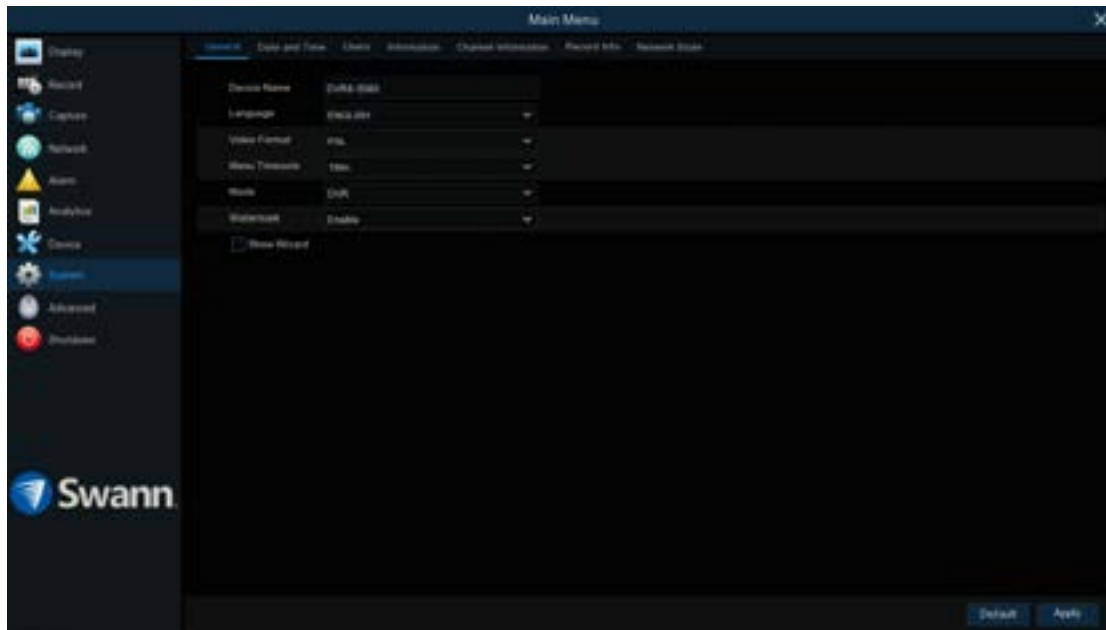

- Click "Default" to revert to default settings.
- Click "Apply" to save settings.

Device Name: Click the dialogue box to rename your DVR (if required).

Language: Select a language you would like the system menus to be displayed in. Multiple languages are available.

Video Format: Select the correct video standard for your country. USA and Canada are NTSC. UK, Australia and New Zealand are PAL.

Menu Timeouts: Click the drop down menu to select the time your DVR will exit the Main Menu when idle. You can also disable this by selecting "OFF" (password protection will be temporarily disabled).

Mode: Your DVR supports an additional mode called XVR. This allows you to configure IP cameras, that are connected to your home network, to work with your DVR. This mode will be covered in a future manual update.

Watermark: By default, the Swann logo is overlaid as a watermark for each camera connected. If this isn't required, click the drop down menu to disable.

Show Wizard: Click the checkbox if you would like to display the Startup Wizard each time you turn on or reboot your DVR.

System: Date and Time

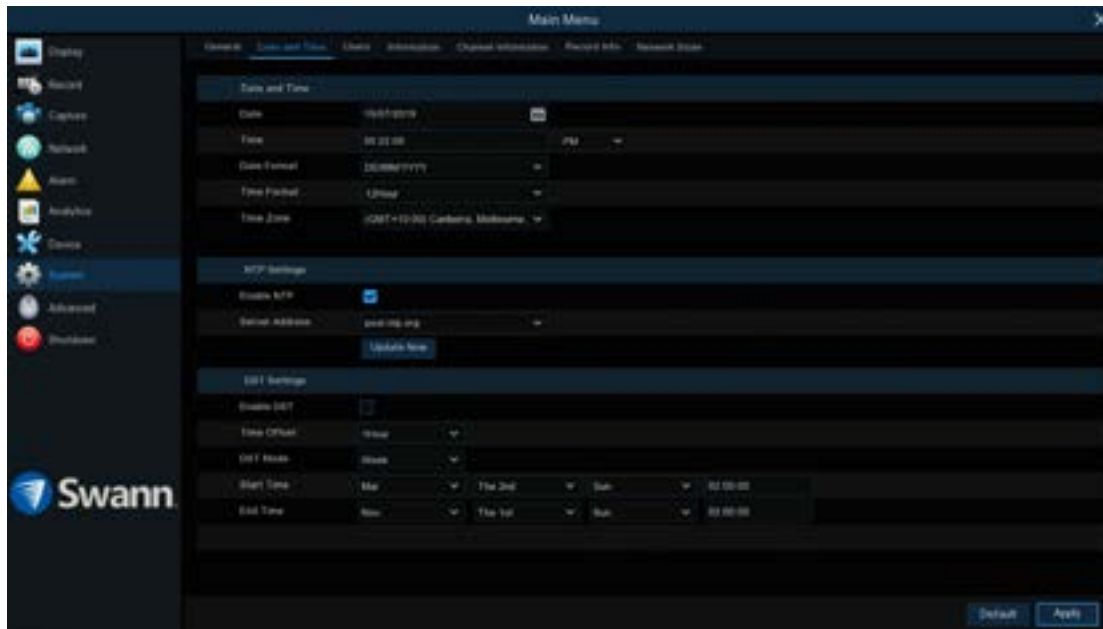

- Click “Default” to revert to default settings.
- Click “Apply” to save settings.

Date and Time

If the date, time and time zone are incorrect, click the relevant dialogue boxes and drop down menus to change.

NTP Settings

The NTP (Network Time Protocol) function gives your DVR the ability to automatically sync its clock with a time server. This ensures that the date and time are accurate and ensures correct time stamping when events occur.

1. Click the “Update Now” button to automatically synchronize your DVR’s internal clock with the time server instantly.
2. A message will appear on-screen stating that the time has been successfully updated. Click “OK” to continue.

DST Settings

Enable DST: If Daylight Saving applies to your time zone or region, click the drop down menu to enable.

Time Offset: Select the amount of time that Daylight Saving has increased by in your time zone. This refers to the difference in minutes, between Coordinated Universal Time (UTC) and the local time.

DST Mode: You can select how Daylight Saving starts and ends:

Week: Select the month, a particular day and time when Daylight Saving starts and ends. For example, 2 a.m. on the first Sunday of a particular month.

Date: Select the start date (click the calendar icon), end date and time when Daylight Saving starts and ends.

System: Users

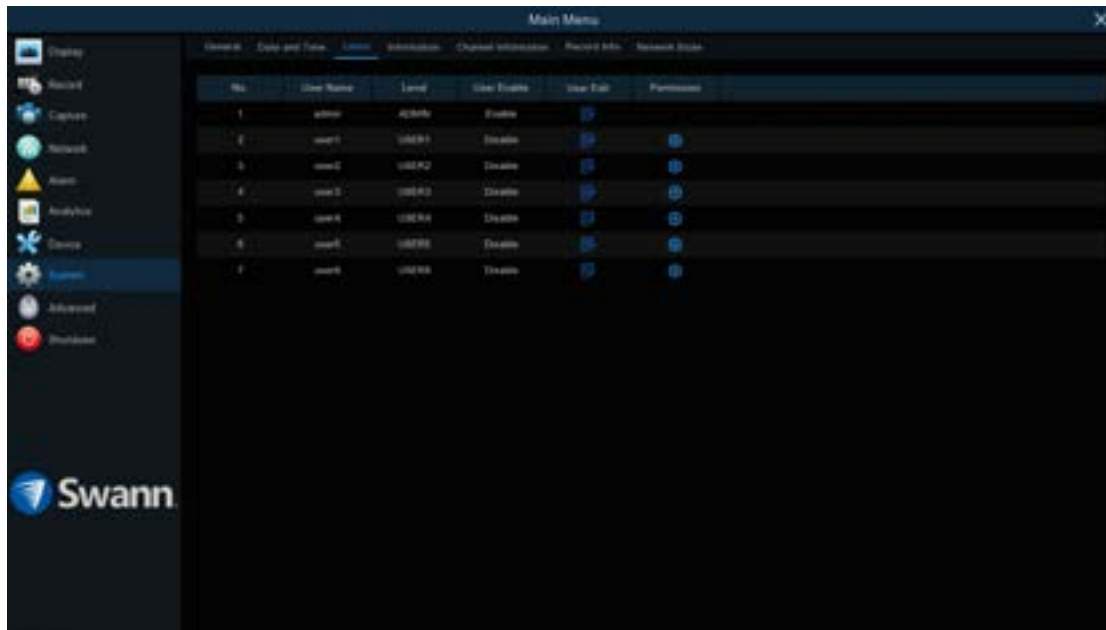

- Click "Default" to revert to default settings.
- Click "Apply" to save settings.

To change your DVR's password, click the "Edit" button. The password has to be a minimum of six characters and can contain a mixture of numbers and letters. Enter your new password again to confirm.

Additional user accounts can also be enabled:

1. Select "user1" then click the "Edit" button.
2. Click the drop down menu to enable.
3. Enter a user name and password.
4. Click the "Save" button, enter the admin password then click "OK" to confirm.

To change permissions, click the "Permission" button then select which options you would like to enable. Click the "All" button to select all options. Click

the "Save" button then click "OK" to confirm.

Advanced: Maintain

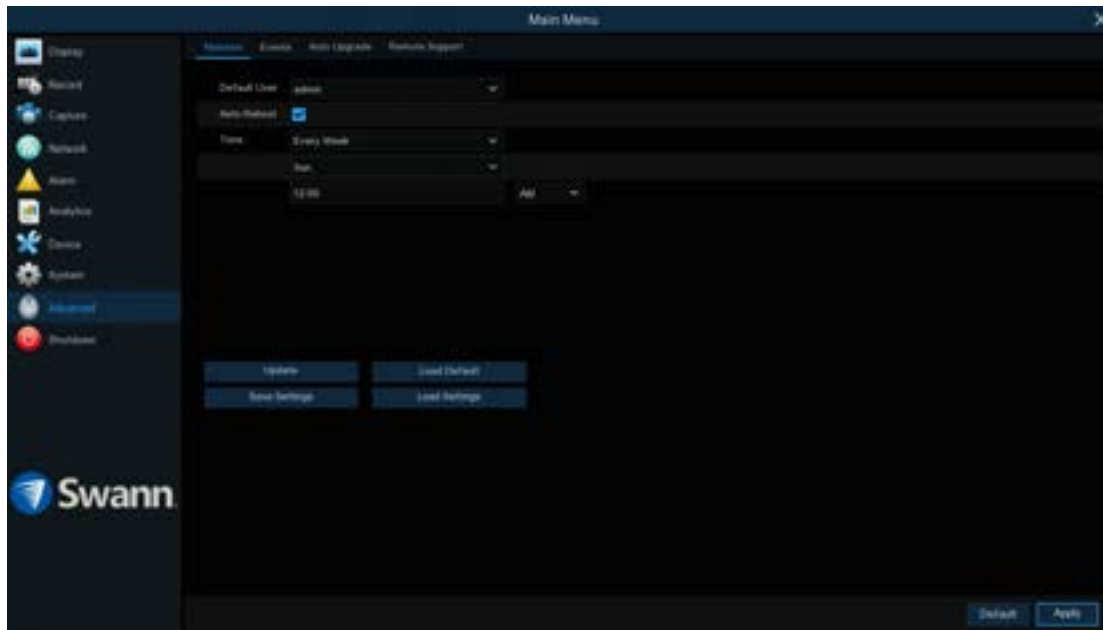

- Click “Default” to revert to default settings.
- Click “Apply” to save settings.

Default User: Admin is the default user account. If multiple user accounts have been created, click the drop down menu to disable.

Auto Reboot: It is recommended to leave this enabled, as it maintains the operational integrity of your DVR.

Time: Choose an appropriate day and time to reboot your DVR.

Update: Click this button to update the firmware from a USB flash drive. Select the firmware file then “OK” to confirm. When the firmware update has completed, your DVR will reboot automatically.

Save Settings: Click this button to export a configuration file containing all the settings that you have customised.

Load Default: Click this button to restore factory default settings. Click “All”

then click “Save”. Your DVR will reboot and the Startup Wizard will appear on-screen.

Load Settings: Click this button to import a configuration file containing all the settings that you have customised.

Advanced: Events

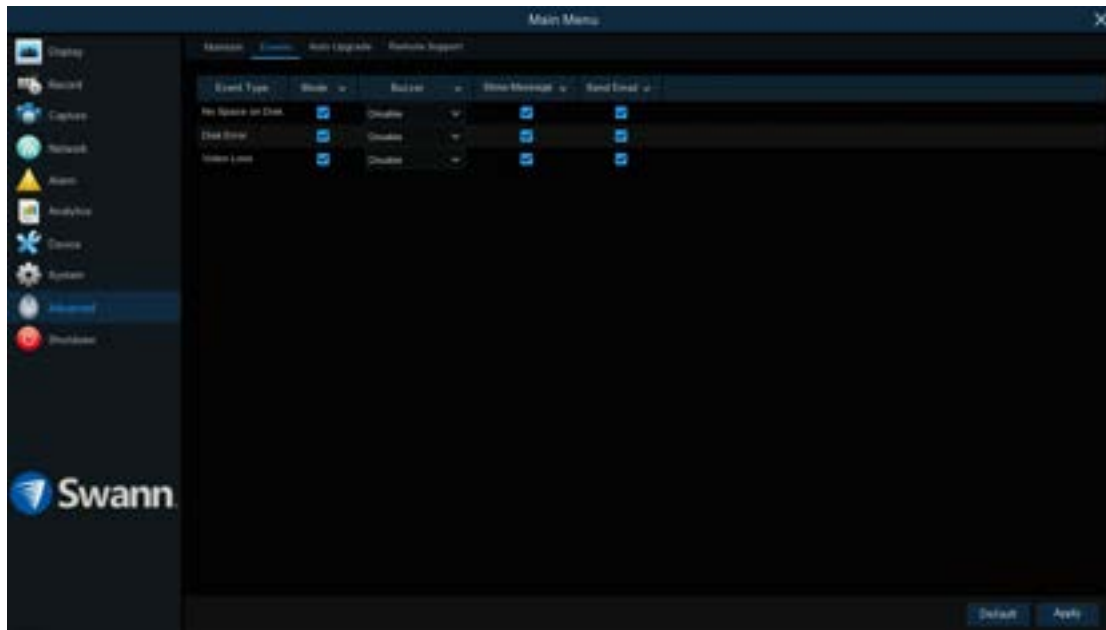

Whenever there is an event or if your DVR displays unusual behaviour, you can be alerted to in multiple ways such as receiving an email, displaying a message on-screen, receiving an alert in the Swann Security app and activating its internal buzzer. There are three event types that your DVR will detect as an exception.

- Click “Default” to revert to default settings.
- Click “Apply” to save settings.

Enable: Click the checkbox if you would like to disable alerts for the event available.

Buzzer: Click the drop down menu and select the time period for the internal buzzer to activate for the event available.

Show Message: Click the checkbox if you like to disable the on-screen message for the event available.

Send Email: Click the checkbox if you would like to disable email alerts for the event available.

Advanced: Auto Upgrade

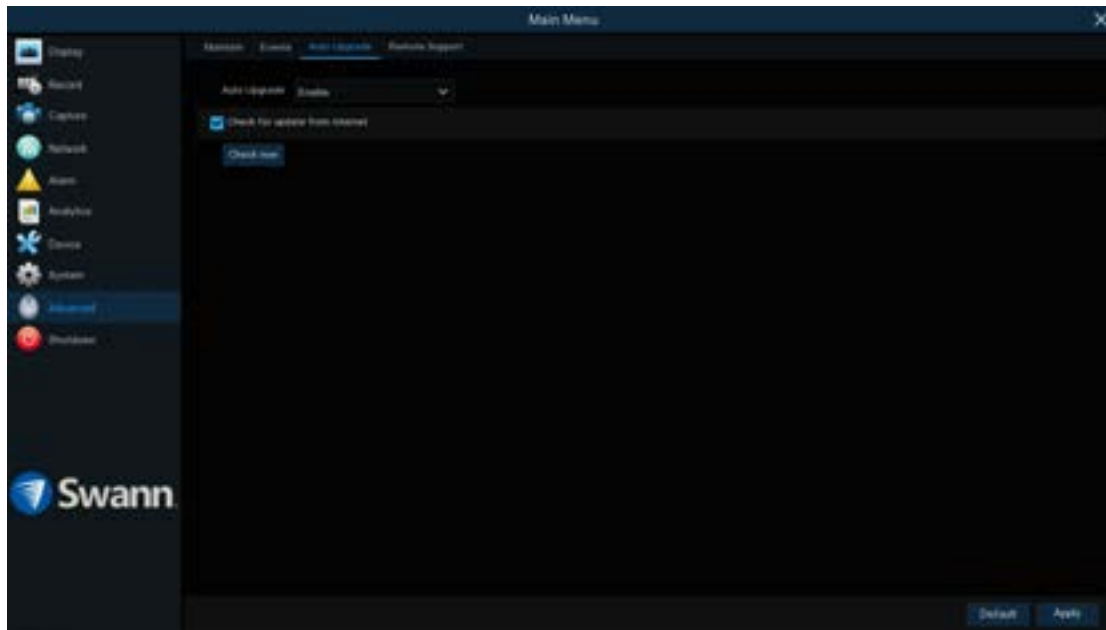

- Click "Default" to revert to default settings.
- Click "Apply" to save settings.

Auto Upgrade: By default, your DVR will automatically download and install new firmware when available. Click the drop down menu if you would like to disable this feature.

Check for update from internet: By default, your DVR will automatically check and alert you if new firmware is available for download. Click the checkbox if you would like to disable this feature.

Check now: Click this button to check if new firmware is available. If new firmware is available, follow the on-screen instructions.

Advanced: Remote Support



If you call for assistance, the Remote Support function can be used by our Swann Helpdesk & Technical Support staff, to remotely connect to your DVR. This will assist them in diagnosing any issues that you may be having. This function is not used in the day-to-day operation of your DVR.

System Status

The various status tabs give you an overview of the various settings and options that have been selected for your DVR to function. Each action that your DVR performs as well as events detected are logged, which you can search and view. If you call our helpdesk for assistance, our staff may ask you to access these tabs to assist them in solving any technical issues that you may be having.

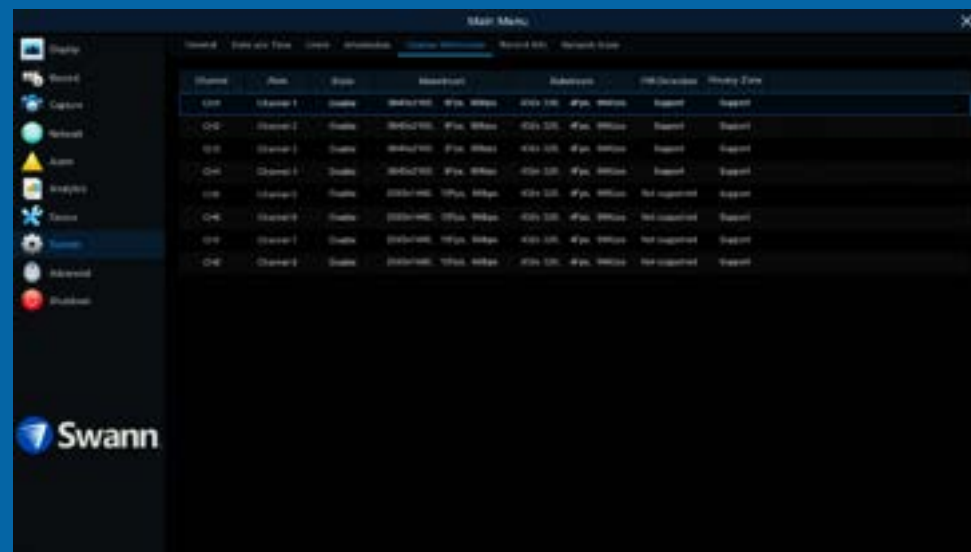

System: Information

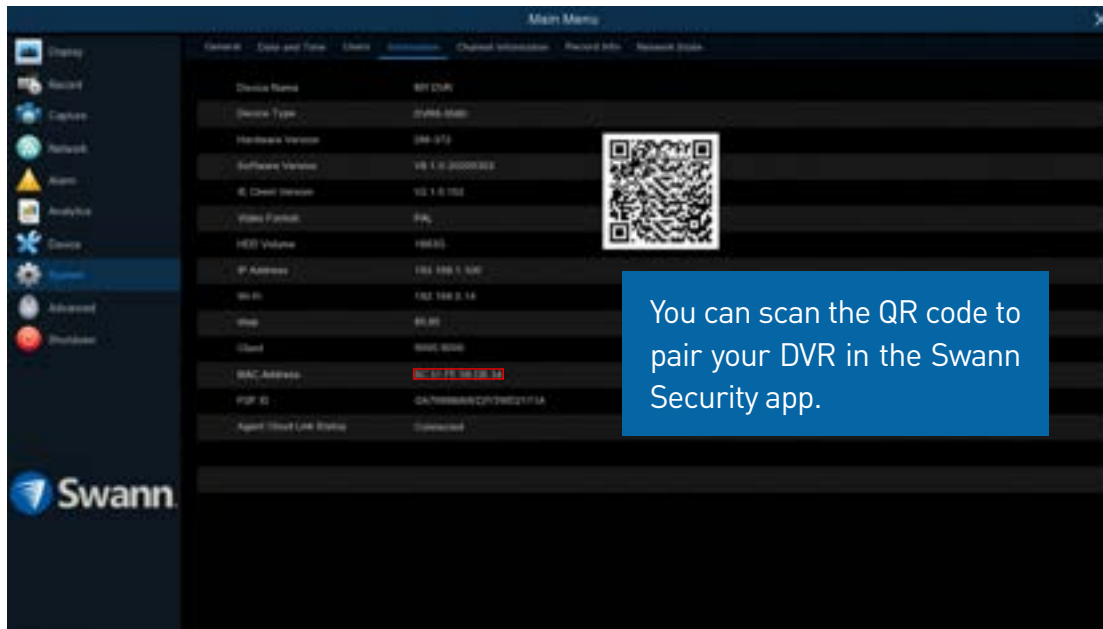

This tab displays technical information about your DVR as well as your device ID (P2P ID) and QR code. If you call our helpdesk for assistance, our staff may ask you to access this tab to assist them in solving any technical issues that you may be having.

MAC Address: You can use this as a recovery password if you have forgotten your current password.

If you call our helpdesk for assistance, our staff may ask you to access this tab to assist them in solving any technical issues that you may be having.

Write down your MAC Address: _____

System: Channel Information & Record Info

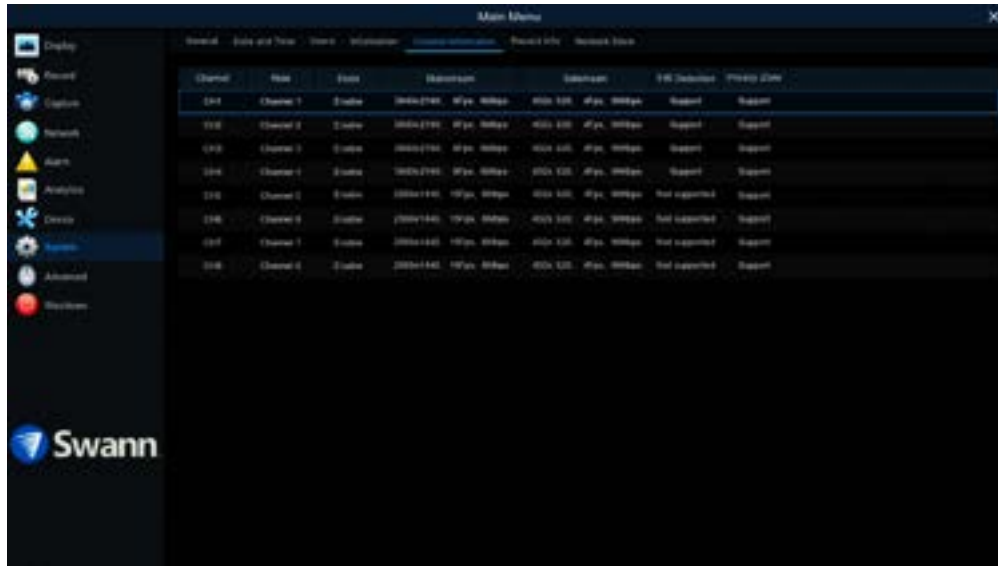

Displays the Mainstream, Substream and the recording settings used for each camera connected (for Record Info, the settings will only be shown when one or more cameras are recording).

If you call our helpdesk for assistance, our staff may ask you to access this tab to assist them in solving any technical issues that you may be having.

Right-click the mouse to exit.

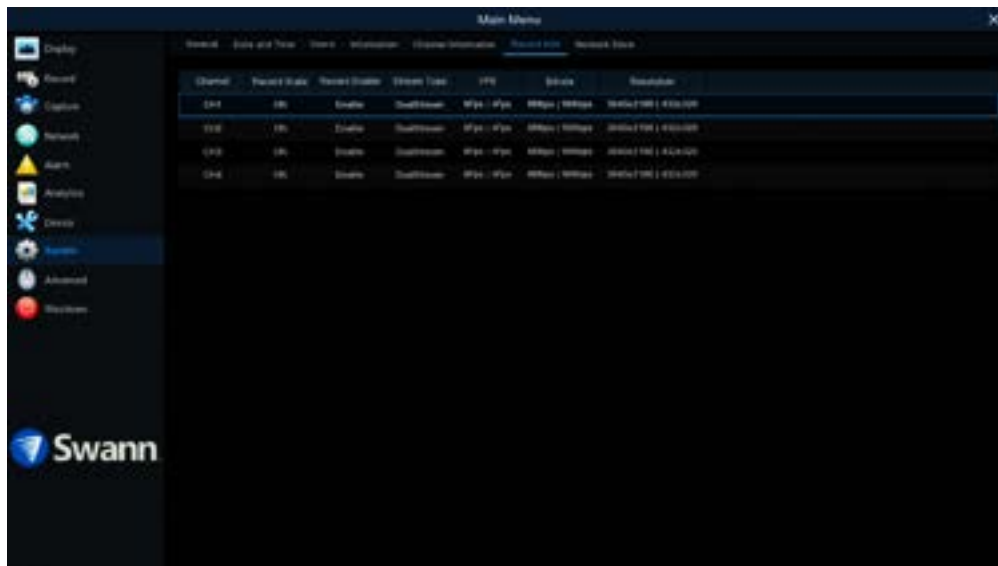

System: Network State

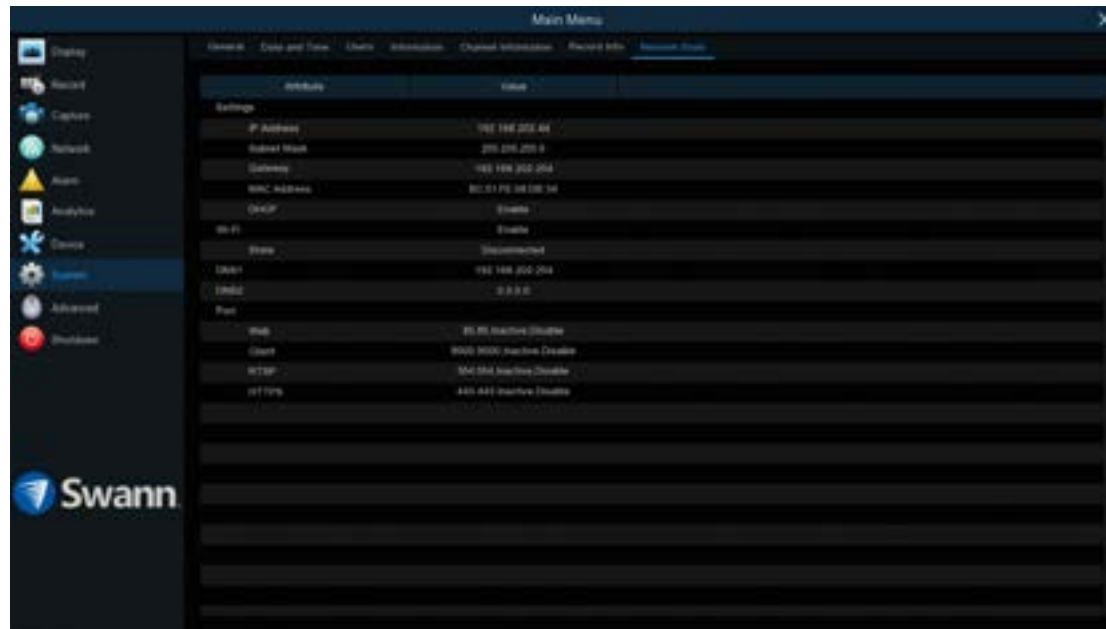

Displays the network settings used by your DVR.

If you call our helpdesk for assistance, our staff may ask you to access this tab to assist them in solving any technical issues that you may be having.

Right-click the mouse to exit.

Search: Log

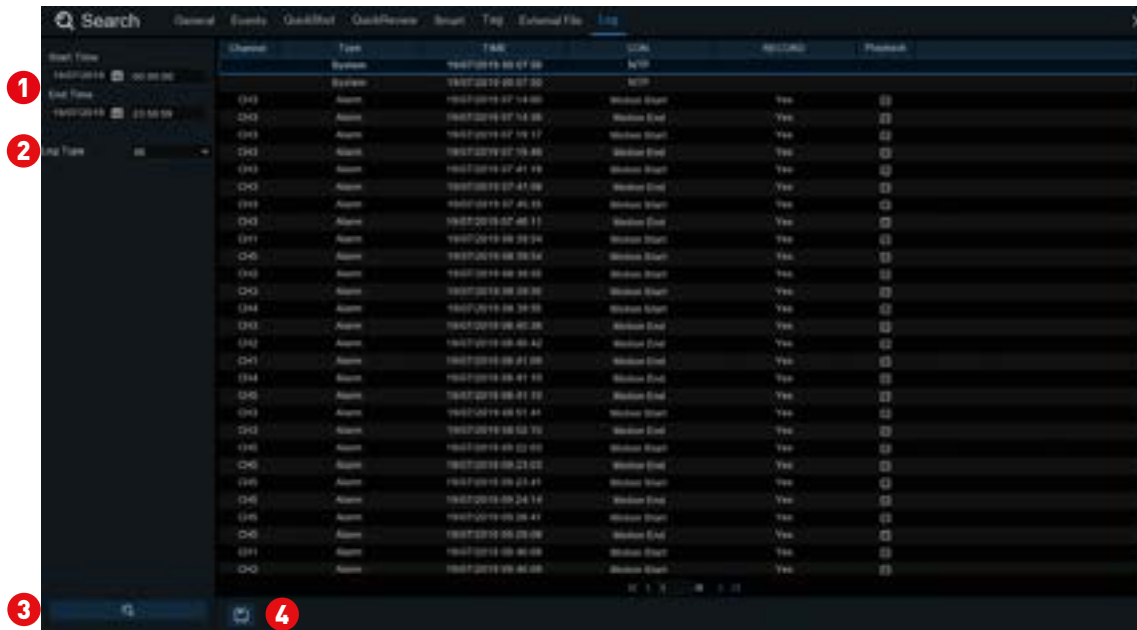

Each action that your DVR performs as well as events detected are logged. These log files can be searched, viewed and copied to a USB flash drive for safe keeping.

- 1 **Start/End Time:** Click the calendar icon to select the month, year and date that you would like to search on. Click the dialogue box to enter a specific start and end time.
- 2 **Log Type:** Leave the default selection or click the drop down menu to select a specific action that you would like to search for.
- 3 **Search:** Click this to display a list of log files that match your search criteria. Double-click a file to display information about that log.
- 4 **Backup:** Insert a USB flash drive to your DVR then click this to copy the log files that match your search criteria. You have the choice of formatting the flash drive or creating a new folder if required. Click "OK" to save then click "OK" again to close.

Glossary

3D-Noise Filter: Is an enhanced form of digital noise reduction. The advancement in technology enables noise to be filtered even more effectively from the image, even in low light conditions.

50Hz: Is the mains frequency used in the UK, Australia and most European countries.

60Hz: Is the mains frequency used in the United States, Canada and some Latin American countries.

AGC (Automatic Gain Control): In low light conditions, the camera will automatically boost the gain control so that people and objects can be seen more clearly. The advantage of this technique is that your camera will produce images in much lower light conditions. The downside is that the amplification will increase the video noise visible.

AHD: Is an analogue high definition closed-circuit television video surveillance standard that uses coax cable to transmit HD video from security cameras to DVRs. AHD supports 720p and 1080p HD video resolutions.

Analytics: Are a series of functions that provide you with much greater control on your DVR or NVR detects motion. Some examples are drawing a detection line and applying a rule on which direction motion is detected or defining specific areas that you want to monitor for motion.

Anti-flicker: As fluorescent lighting operates at the same frequency as your mains power, this will cause luminance flicker when viewed through the camera. Enabling the anti-flicker options available can reduce or eliminate the flicker that is visible.

Anti-smearing: A smear effect means that a bright vertical line originating from a bright light source appears in the image. This happens especially with back lighting. Enabling this allows people and objects to be seen correctly

against a very bright background.

Auto DNS (Domain Name System): A service that stores domain names and translates them into internet protocol addresses. For example, www.google.com will have a DNS server address that is equivalent to 74.125.224.72. The DNS server is automatically provided by your internet service provider.

Auto-focus: Will adjust the lens of your camera to focus on an object being viewed.

Bandwidth: In computer networks, bandwidth is used as a synonym for data transfer rate, the amount of data that can be carried from one point to another in a given time period (usually a second). Network bandwidth is usually expressed in bits per second (bps).

Bitrate: The amount of data that your DVR or NVR will use to record video. The higher the bitrate, the more space each recording will consume on the hard drive. Increasing this will also consume more bandwidth when streaming. Unit of measurement is either Mbps (megabits per second) or kbps (kilobits per second).

BLC (Back Light Compensation): Improves exposure of an object that is in front of a light source. It does this by splitting the whole image into different regions, and then applying separate exposure levels to those regions.

Brightness: This changes how light the image appears to be. Its value is different in darkness to that in daylight. For example, the lights from car headlights appears to be brighter at night.

CDS: This allows the image to be set by the camera's light sensor. A CDS sensor is basically a resistor that changes its resistive value (in ohms) depending on how much light is shining onto the sensor.

Glossary

Cloud: Cloud computing is a model for delivering information technology services in which resources are retrieved from the internet through web-based tools and applications rather than a direct connection to a server. Services such as Dropbox, Google Drive and Microsoft OneDrive are just some of the examples of cloud computing.

Compound Stream: Indicates that your DVR or NVR is recording video and audio at the same time.

Contrast: This increases the difference between the blackest black and the whitest white in the image. Without contrast you wouldn't have an image because there wouldn't be any differentiation between light and dark.

Covert: The camera will detect motion and trigger your DVR or NVR to record, but you will not see an image of the camera in Live View mode.

DDNS (Dynamic DNS): Is a service that converts IP addresses into host names (a host name is a lot easier than trying to remember an IP address). It also supports dynamic IP addresses, such as those assigned by a DHCP server. This makes DDNS a good fit for home networks, which normally receives an IP address from the ISP that will change occasionally.

DHCP (Dynamic Host Configuration Protocol): Uses an appropriate server or router to enable dynamic assignment of an IP address to a device connected to the network.

Display Resolution: Is the number of pixels supported by your TV or VGA monitor or the output signal of a viewing device, e.g. your DVR or NVR.

DNS Server: Is a standard technology for managing public names of web sites and other internet domains. DNS technology allows you to type names into your web browser which your computer will automatically find the address on the internet.

Dropbox: Is a file hosting service that allows you to store and share snapshots and video recordings from your DVR or NVR.

DST (Daylight Saving Time): Is the period of the year when clocks are moved one hour ahead.

DualStream: A process where your DVR or NVR will record both Mainstream and Substream video at the same time.

Format: Is a command that prepares a storage device such as a USB flash drive or hard drive to hold data.

Firmware: The software that operates a discrete device (e.g. your smartphone). It is referred to in this way rather than software as it is integral to the operation of the device.

Frame Rate: The measurement of the rate that pictures are displayed to create a video feed. The unit of measurement is frames per second (fps).

Gateway: Is a node or router that routes traffic from a device on your home network to the outside network that is providing access to the internet.

H.264+: Mass video data requires increased storage capacity. To resolve this issue, video compression technologies are used to reduce the data while maintaining image quality. H.264+ is an innovative encoding technology aimed at surveillance video.

H.265: Is a video compression standard and one of several potential successors to the widely used H.264. It offers double the data compression ratio at the same level of video quality.

Hardware: A physical device such as your DVR or NVR.

HDD (Hard Disk Drive): Is a storage device located inside your DVR or NVR. It is where all data is kept, saved and stored.

Glossary

HTTP Port (Hypertext Transfer Protocol): This port is used to log into the web browser interface of your DVR or NVR (if available) using a web client.

Hue: Is somewhat synonymous to what is usually referred to as colors. By altering the hue, you can change the color mix of the image.

IP Address: The address of a device attached to the network. Each device on the network must use a unique address.

IP Filtering: Is a great way to limit access to your network devices for specific groups of IP addresses.

Live View: Is the default display mode for your DVR or NVR. Each camera connected will be displayed on-screen.

MAC Address: Is a unique identifier for network hardware. Can also be used as a super password if you have forgotten your current password.

Mainstream: Is the video stream that your DVR or NVR will display and record.

Mask: Is used to obscure part of your image for privacy. It can also be used to minimise false triggers when your DVR or NVR detects motion. Any area obscured won't be shown live or recorded.

Menu: Is where you control the various actions and options that are available on your DVR or NVR.

Motion Detection: Is the main method used by your DVR or NVR to detect motion and is an essential part of your security system. It does this by comparing one frame of video with the next. A certain amount of difference between these two frames is interpreted as motion.

NAS (Network Attached Storage): A network device with one or more HDDs that other network devices can use as if the storage was connected directly.

NIC (Network Interface Controller): The hardware component that allows a device to connect to a network.

NTP (Network Time Protocol): Is used to synchronize your DVR or NVR's clock automatically with a network time server. Most time servers are on the internet.

NTSC: Is the video system used in North America, Canada and some Latin American countries. In NTSC, 30 frames are transmitted each second.

Optical Zoom: Is a true zoom feature. It allows you to zoom in (or out) on an object to get a closer view by using the camera's lens.

OSD (On-screen Display): Display information from the camera such as time, date and camera name on-screen.

Overscan: Is mainly used on older television sets to display the entire viewable area correctly on-screen. It does this by cutting off the edges of the picture. This is not required for modern Plasma and LCD TVs as the image is digitally processed to display the correct aspect ratio.

Pack Duration: Instructs your DVR or NVR to split recordings into discrete units. Each unit can be a maximum of 60 minutes in length. Your DVR or NVR will play these as one continual video.

PAL: Is the video system used in the United Kingdom, Australia and most European countries. In PAL, 25 frames are transmitted each second.

PIR (Passive Infrared): Cameras that have a built-in PIR sensor can sense movement of warm objects including people, cars and animals.

Post-record: Instructs your DVR or NVR to record for a set period of time after an event has occurred.

Glossary

PPPoE (Point-to-Point Protocol over Ethernet): Is the most common method that your router uses to login to your ISP to enable your internet connection. This setting also exists on the DVR or NVR, but is only for advanced users as the configuration required is difficult to complete.

Pre-record: Allows your DVR or NVR to record for a number of seconds before an event occurs.

Privacy Zone: See Mask for information.

Resolution: The measure of detail that can be seen in an image. The higher the number, the greater the detail available.

RTSP (Real Time Streaming Protocol): A network protocol designed to transmit video and audio information over networks and the internet in real time.

Saturation: This alters how much color is displayed in the image. The higher the saturation, the more bright and vivid colors will appear.

Server Port: Is a logical connection place and specifically, using the internet protocol TCP/IP, the way a client program specifies a particular server program on a computer in a network.

SEQ: Puts the DVR or NVR in sequence mode. This will repeatedly cycle through each video channel for a predetermined time in Live View mode.

S.M.A.R.T. (Self-Monitoring, Analysis & Reporting Technology): This is an automatic system on modern HDDs and SSDs to detect potential drive errors before they occur.

SMTP (Simple Mail Transfer Protocol): This is used to send an outbound email (e.g. from your DVR or NVR to an email address).

SMTP Port: Is the port number used by a SMTP server to listen for email

send requests. This is specified by your email provider.

SMTP Server: This is the address of the server used for SMTP. Usually in the form of a web address (e.g. smtp.gmail.com).

Software: A set of instructions that runs on a computing device.

SSID: Is the technical term for a wireless network name. When you setup a wireless network, you give it a name to distinguish it from other networks in your neighbourhood.

SSL (Secure Socket Layer): A secure method for connecting to servers. In the context of the DVR or NVR, primarily used for email server connections.

Static: When referring to IP addresses, this is where a device's IP address has been manually entered. Sometimes used on older devices without UIDs to prepare for internet access.

Static DNS: In some circumstances, your internet service provider may require you to use a static DNS instead of an auto DNS on your router.

Substream: Is the video stream that your DVR or NVR will send to remote devices via the network or internet. Video quality is reduced to make it easier to send.

Subnet Mask: Used to define which part of the IP address refers to the network location.

Tag: Allows you to record information such as a person or object within a video. You can then commence a search so tags matching your criteria will be displayed. This is a faster method of identification when searching.

Time Server: Is a server that reads the actual time from a reference clock and distributes the information to its clients on the network.

Glossary

Time Zone: Is a region that observes a uniform standard time for legal, commercial, and social purposes. It is convenient for areas in close communication to keep the same time.

Timestamp: Is a sequence of characters or encoded information identifying when a certain event occurred, usually giving date and time of day, sometimes accurate to a small fraction of a second.

TVI: Is a digital signal processing and transport technology for video used in HD security cameras. TVI cameras currently support 1080p video resolution using the same coaxial cabling techniques used by traditional CCTV cameras.

UID (Unique Identifier): Is an alphanumeric string that is associated with a single entity within a given system. By entering your UID into the mobile app or computer software, this allows you to communicate with your DVR or NVR without having to remember IP addresses or port numbers.

UPnP (Universal Plug and Play): A network protocol designed to allow network connected devices to automatically configure the router for the purposes of remote access. Not required to be enabled when using UID.

VCA (Video Content Analysis): Is a new method for triggering recording and events. This uses the image processing system of the DVR or NVR & camera to set specific triggers for recording (such as line crossing or intrusion). This system does use more processing power, therefore it may not be available on all devices.

Video Loss: Is regarded as a potential alarm event and is considered to occur any time your DVR or NVR doesn't receive an active video signal from any one of its video inputs.

Video Quality Diagnostics: Enables your DVR or NVR to alert you if the camera has a blurred image, abnormal brightness or unwanted tint in the image

due to the lighting and white balance of the camera (known as Color Cast).

Video Stream: Indicates that your DVR or NVR is recording a video stream only.

Watermark: Is an identifying image (usually a logo) that is intentionally superimposed onto another image. Its purpose is to make it more difficult for the original image to be copied or used without permission.

WDR (Wide Dynamic Range): Is technology to balance out images that have a large dynamic range. An example of this situation would be if an indoor camera were pointing towards a window or building entrance. The image produced by the camera during the day would be extremely washed out due to the high brightness of the incoming light.

Wi-Fi: Is a wireless networking protocol that allows devices to communicate without direct cable connections.

Password Recovery using HomeSafe View

I haven't created an email for my DVR, what can I do? Don't worry, you can use HomeSafe View to retrieve your recovery code. You can use this to reset your DVR's password. Download the relevant version for your computer and follow the on-screen instructions to complete installation.

HomeSafe View Windows click [here](#). **HomeSafe View Mac** click [here](#).

1. When you first run HomeSafe View, you will see an introduction screen. Click "Next" to continue. You will see the following screen:

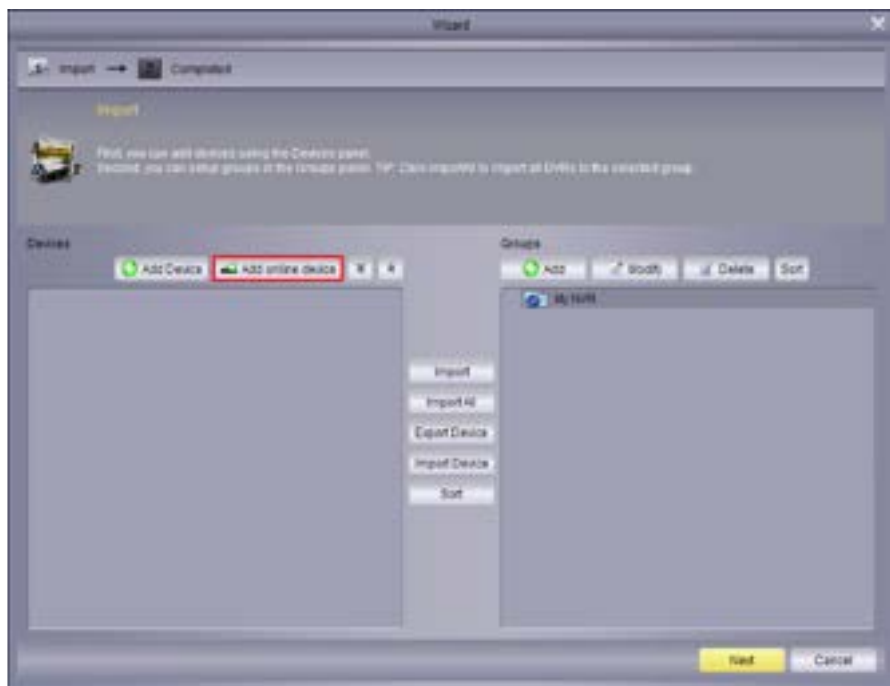

2. To display your DVR connected to your router, click the "Add online device" button as shown above (if your DVR does not appear, check that your device is connected to your router using the supplied Ethernet cable).



3. You will see this screen as shown above. Click your DVR to display its MAC Address. This is your recovery code that is used to reset the password. Write this down and replace the dashes (-) with colons (:).

4. Now it's time to enter the recovery code on your DVR. Right-click the mouse on the Live View screen to display the Menu Bar then click "Main Menu". The login prompt will appear on-screen:

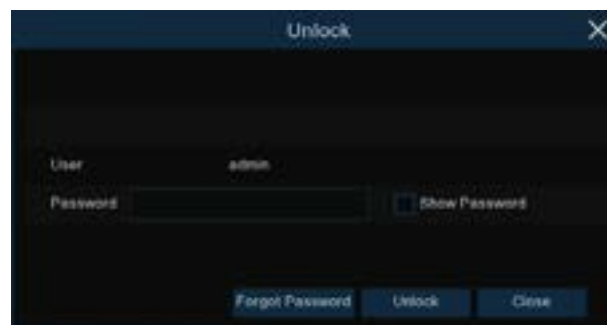

(continued on next page)

Password Recovery using HomeSafe View

5. Click “Forgot Password”. A message will appear on-screen:

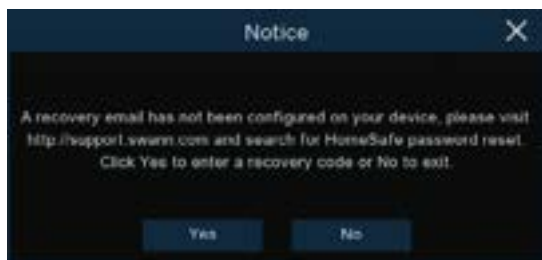

Click “Yes” to continue. The recovery code prompt will appear on-screen:



Click the dialogue box, enter the recovery code (MAC Address), for example BC:51:FE:02:B3:42 then click “OK”. A message will appear on-screen stating that the password has been reset. Click “OK” to continue.

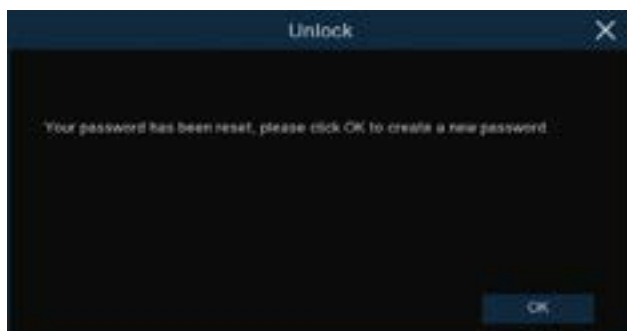

6. You will now be prompted to enter a password:



The password has to be a minimum of six characters and can contain a mixture of numbers and letters. Use a password that you are familiar with, but is not easily known to others. Write down your password for safe keeping. When finished click “Save”. You will now see the following screen:

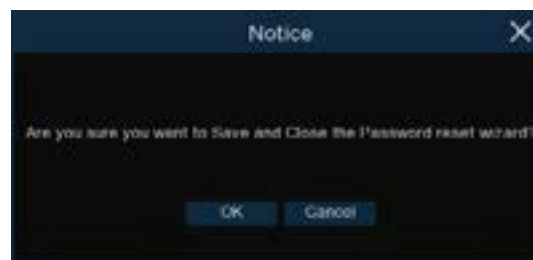

Click “OK” to finish.

Don't forget to write down your password: _____

Installing an Internal Hard Drive

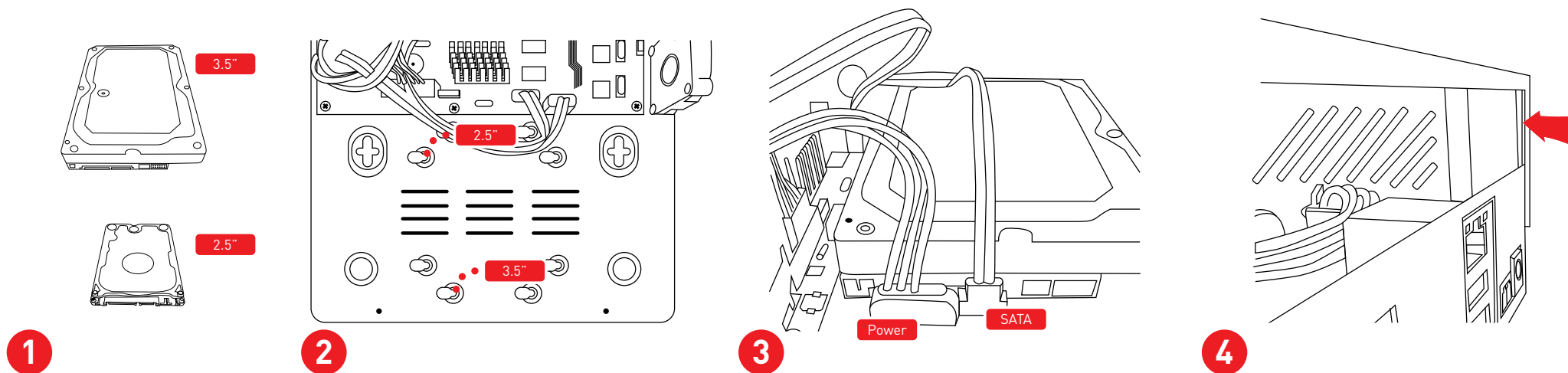

Your DVR supports recording to either a 3.5" SATA or a 2.5" SATA hard drive. The largest hard drive you can connect is 6TB (terabyte). We recommend that you purchase a drive that is surveillance rated such as the Western Digital Purple™ and Seagate Skyhawk™ range of drives.

1 Place the DVR onto a flat surface and use a Phillips head screwdriver to remove the two screws located underneath and the screws on the left and right-hand sides. When finished, flip the DVR over and gently open the lid starting from the rear. Don't remove the lid fully as there are data cables attached to the front USB ports and LEDs.

2 There are eight mounts available to secure the hard drive to the DVR. Four mounts are for a 3.5" drive and the other four are for a 2.5" drive. To easily mount the hard drive, gently flip the drive over and screw in each supplied screw. Don't screw them all the way, just enough for each screw to hold its position. You're now ready to mount the drive.

3 Slide the hard drive into the relevant mounts then connect the power and data (SATA) cable to the relevant connections on the drive. Hold the drive and carefully lift the DVR upwards to a 90 degree position. Use a Phillips head screwdriver to fasten each screw.

4 Place the lid back onto the DVR. There is a plastic groove at the rear of the lid. Make sure the groove that is on each side, slides into the metal chassis when closing the lid. Fasten the remaining screws to finish.

5 To start using the hard drive, you need to format it first (see page 118 - [Device: HDD](#)).

Can I connect and record to a portable USB hard drive? Only the DVR-4480 model supports this feature. Connect a USB hard drive to the rear USB port marked "Storage" (the ports located at the front are for backup purposes only). Both self-powered and USB hard drives that have their own power adapter are compatible. Just be aware, not all USB hard drive models are supported.

Frequently Asked Questions

Can I play video(s) on my DVR that I have copied to a USB flash drive?

Yes, you can use the Search: External File function (see [page 107](#)).

What is the largest hard drive that I can install inside my DVR?

The largest hard drive you can install is 6TB (terabyte). We recommend that you purchase a drive that is surveillance rated such as the Western Digital Purple™ and Seagate Skyhawk™ range of drives.

Can I connect and record to a portable USB hard drive?

No, your DVR will only record to the internal hard drive that is installed.

Can I connect and copy videos to a portable USB hard drive?

Due to the nature of how portable USB hard drives operate, there is no guarantee that your drive, when connected to the DVR's USB port, will work. You'll have to give it a try. For backup purposes, we recommend using a USB flash drive.

How do I save video recordings that are on my DVR?

To copy video recordings to a USB flash drive, use the Search: Events function (see [page 99](#)).

How do I save snapshots that are on my DVR?

To copy snapshots to a USB flash drive, use the Search: QuickShot function (see [page 101](#)).

Can I use my own email address and server instead of creating a new one?

You can providing you have the settings required for the SMTP port and server. If you don't have this, you will have to contact your internet service provider to get this information.

My DVR has an audio input, what can I use this for?

As your DVR has a standard RCA audio input, any type of audio source that has a RCA audio output, can be connected. A microphone can also be connected providing it has its own power source (do a Google search on CCTV audio microphone).

How do I connect the audio output on my DVR?

Connection of the audio output isn't required when connecting your DVR to a TV using a HDMI cable. If you are using a monitor and VGA cable for display, you can connect the DVR's audio output to an amplifier that has a RCA audio input. This will allow you to hear audio that you may have connected to the DVR's audio input.

I have saved recordings to a USB flash drive to play on my Windows computer but it won't play in Windows Media Player, how can I play these?

Windows Media Player doesn't have the required codecs to play recordings from your DVR. We recommend using VLC media player as it has the required codecs to play a variety of different video formats. It's free to download from www.videolan.org.

When I search for events in Search: General I see an orange lock symbol on one of the cameras and I can only select four cameras, why can't I select the other cameras?

For playback of events, a maximum of four cameras can selected at any one time. By default, channels 1 to 4 are selected. To select other channels, click the "Channel" checkbox and select the other cameras to display for playback. When four cameras have been selected, the orange lock symbol will appear on one of the cameras.

Warranty Information

USA

Swann Communications USA Inc.
12636 Clark Street
Santa Fe Springs CA 90670
USA

Australia

Swann Communications
Suite 5B, 706 Lorimer Street
Port Melbourne Vic 3207
Australia

United Kingdom

Swann Communications LTD.
Stag Gates House 63/64 The Avenue
S0171XS
United Kingdom

Warranty Terms & Conditions

Swann Communications warrants this product against defects in workmanship and material for a period of one (1) year from its original purchase date. You must present your receipt as proof of date of purchase for warranty validation. Any unit which proves defective during the stated period will be repaired without charge for parts or labour or replaced at the sole discretion of Swann. The end user is responsible for all freight charges incurred to send the product to Swann's repair centres. The end user is responsible for all shipping costs incurred when shipping from and to any country other than the country of origin.

The warranty does not cover any incidental, accidental or consequential damages arising from the use of or the inability to use this product. Any costs associated with the fitting or removal of this product by a tradesman or other person or any other costs associated with its use are the responsibility of the end user. This warranty applies to the original purchaser of the product only and is not transferable to any third party. Unauthorized end user or third party modifications to any component or evidence of misuse or abuse of your device will render all warranties void.

By law some countries do not allow limitations on certain exclusions in this warranty. Where applicable by local laws, regulations and legal rights will take precedence.

For Australia: Our goods come with guarantees which cannot be excluded under Australian Consumer Law. You are entitled to a replacement or refund for a major failure and for compensation for any other reasonably foreseeable loss or damage. You are also entitled to have the goods repaired or replaced if the goods fail to be of acceptable quality and the failure does not amount to major failure.

Help & Resources

Visit Swann Support Center at support.swann.com. You can register your product for dedicated customer support, download guides, find answers to commonly asked questions, and more.



Product Registration



Customer Support



Product Manuals



Frequently Asked Questions



Support Community



Tell us what you think!

We are constantly working to improve the quality of our documentation, and we would appreciate your feedback. Click [here](#) to complete a short survey.