

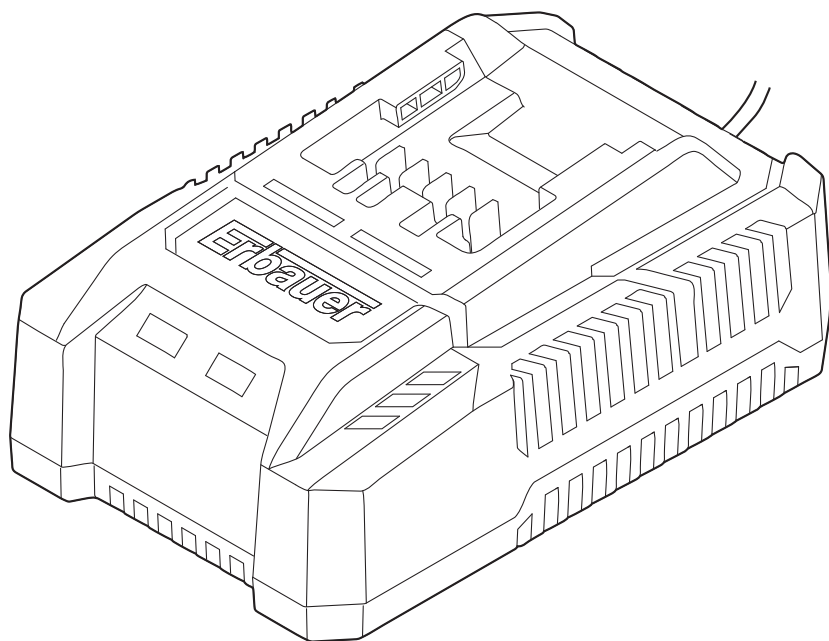

Erbauer



MNL_EC12-Li_V01_180608

EAN. 3663602461777

EC12-Li

ORIGINAL INSTRUCTIONS

EN



Safety instructions



Product description



Assembly



Use



+



Care & maintenance



Guarantee



Declaration of Conformity



WARNING! Please read all safety warnings carefully and be sure that they are fully understood before handling the tool.

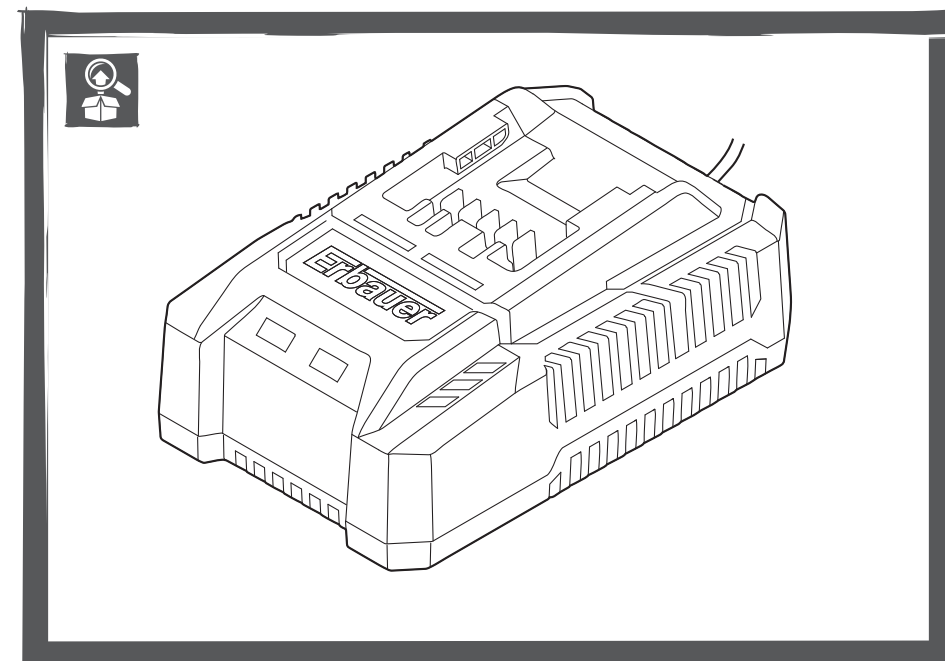

PRODUCT DESCRIPTION

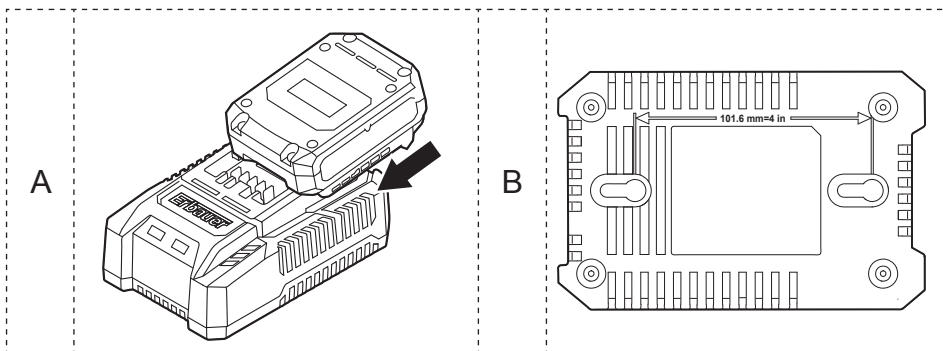
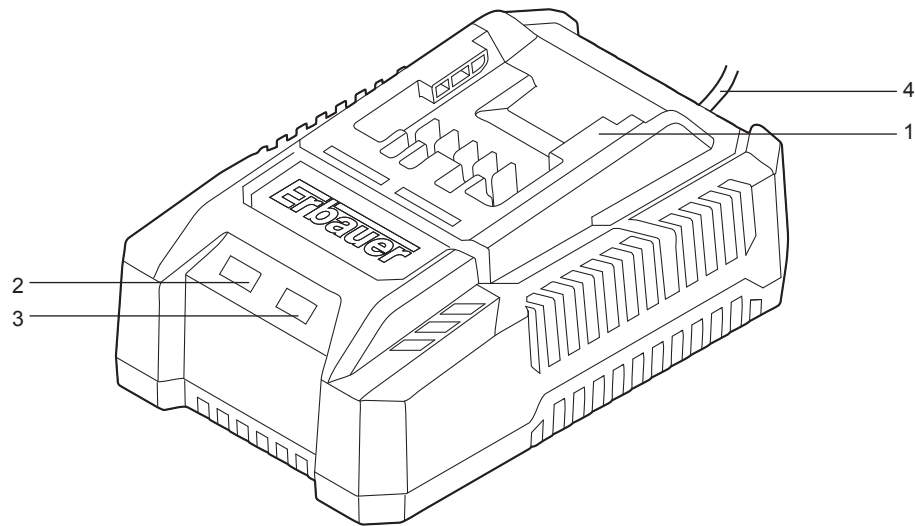

SAFETY INSTRUCTIONS



WARNING! Read all safety warnings and all instructions. Failure to follow the warnings and instructions may result in electric shock, fire and/or serious injury.

Save all warnings and instructions for future reference.

- a. This appliance can be used by children aged from 8 years and above and persons with reduced physical, sensory or mental capabilities or lack of experience and knowledge if they have been given supervision or instruction concerning use of the appliance in a safe way and understand the hazards involved. Children shall not play with the appliance. Cleaning and user maintenance shall not be made by children without supervision.
- b. If the supply cord is damaged, it must be replaced by the manufacturer, its service agent or similarly qualified persons in order to avoid a hazard.
- c. Charger is for indoor use only.
- d. When the charger is in use it **MUST** be supervised, if there is any evidence of overheating then **IMMEDIATELY** disconnect the charger from the power supply.
- e. If gas or smoke is emitted from the battery during charging switch off the power supply and move to a well vented area.
- f. Always disconnect battery charger and remove battery from charger when the charging is complete.
- g. Only charge the battery pack specifically stated on this instruction manual.
- h. Do not charge a damaged battery pack.

- i. Do not charge non-rechargeable batteries.
- j. Always charge the battery pack between temperatures 5°C to 40°C. Ideal charging temperature is 18°C to 24°C.

IMPORTANT NOTE

Be sure the supply is the same as the voltage given on the rating plate for the charger. The charger is fitted with a two-core cable and plug. Remove the mains plug from socket before carrying out any adjustment or servicing.



PRODUCT DESCRIPTION

1. Charger
2. Red LED light
3. Green LED light
4. Cable & plug

01 TECHNICAL SPECIFICATIONS

Rated input	220-240 V ~ 50-60Hz 40W
Rated output	12.6 V d.c. 2.4A
Protection class	II / 
Weight:	approx. 0.5 kg

For charging: 12V Li-Ion battery packs as below

Battery pack model:	EBAT12-Li-2
Rated capacity:	2Ah
Battery cells:	3.6V x 3pcs
Charging time(Approx.)	60min

RATING LABEL EXPLANATION

EC12-Li = MODEL NUMBER	E = ERBAUER
	C = Charger
	12 = 12V
	Li = LITHIUM ION



ASSEMBLY

01 SYMBOLS



Warning



Class II equipment



For indoor use only



Read the operator's manual



Time lag fuse with rated current of 2.0A



Positive terminal



Negative terminal

yyWxx Manufacturing date code: Year of manufacturing (20yy) and week of manufacturing (Wxx)

02 UNPACKING

Unpack all parts and lay them on a flat, stable surface.

- Remove all packing materials and shipping devices, if applicable.
- Make sure the delivery contents are complete and free of any damage. If you find that parts are missing or show damage do not use the product but contact your dealer. Using an incomplete or damaged product represents a hazard to people and property.
- Ensure that you have all the accessories and tools needed for assembly and operation. This also includes suitable personal protective equipment.



WARNING! The product and the packaging are not children's toys!
Children must not play with plastic bags, sheets and small parts! There is a danger of choking and suffocation!



USE

01 INTENDED USE

This charger is solely for the charging of batteries listed in the TECHNICAL SPECIFICATION section.

CHARGING YOUR BATTERY PACK (A)



WARNING! The charger and battery pack are specifically designed to work together so do not attempt to use any other devices. Never insert or allow metallic objects into your charger or battery pack connections because an electrical failure and hazard will occur.

1. Slide the battery pack onto the charger.
2. Connect the charger to a suitable power supply.
3. The LED lights on charger show different status as below.

RED LED	GREEN LED	STATUS	REMARK
On ●	Off ○	HOT/COLD Battery 	The charger will recover to charge when the temperature drops to 40°C or raises to 5°C
Flashing 	Off ○	Defective 	Battery pack or charger is defective
Off ○	Flashing 	Charging 	
Off ○	On ●	fully charged 	Disconnect charger from power supply and remove battery pack from charger

WALL-MOUNT HOLES (B)

The charger has hanging holes for convenient storage. Install screws in the wall 4 inches (101.6 mm) apart. Use screws sufficiently strong to hold the combined weight of the charger and battery pack .

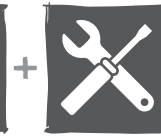

CARE & MAINTENANCE



WARNING! Remove the plug from the socket before carrying out any adjustment, servicing or maintenance.

Your battery charger requires no additional lubrication or maintenance. Never use water or chemical cleaners to clean your charger. Wipe clean with a dry cloth. Always store your charger in a dry place.

ENVIRONMENTAL PROTECTION



Waste electrical products should not be disposed of with household waste. Please recycle where facilities exist. Check with your Local Authority or retailer for recycling advice. For further information visit www.recycle-more.co.uk.

PLUG REPLACEMENT

If you need to replace the fitted plug, then follow the instructions below.

IMPORTANT: The wires in the mains lead are coloured in accordance with the following code:

BLUE – NEUTRAL BROWN – LIVE

As the colours of the wire in the mains lead of this product may not correspond with the coloured marking identifying the terminals in your plug, proceed as follows. The wire, which is coloured blue, must be connected to the terminal, which is marked with N or coloured black. The wire, which is coloured brown, must be connected to the terminal, which is marked L or coloured red.

5 AMP fuse approved to BS 1362

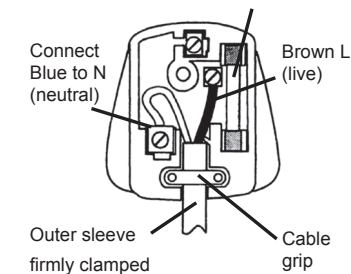



WARNING! Never connect live or neutral wires to the earth terminal of the plug, which is marked with E.

Only fit an approved 13 Amp BS1363 or BS1363/A plug and the correctly rated fuse. If in doubt, consult a qualified electrician.



NOTE: If a moulded plug is fitted and must be removed take great care in disposing of the plug and severed cable, it must be destroyed to prevent engaging into a socket.



GUARANTEE

At **Erbauer** we take special care to select high quality materials and use manufacturing techniques that allow us to create ranges of products incorporating design and durability. That's why we offer a 2 year trade guarantee against manufacturing defects on our **Erbauer** power tool products.

This power tool is guaranteed for 2 years from the date of purchase, if bought in store, delivered or bought online. You may only make a claim under this guarantee upon presentation of your sales receipt or purchase invoice. Please keep your proof of purchase in a safe place.

This guarantee covers product failures and malfunctions provided the **Erbauer** power tool was used for the purpose for which it is intended and subject to installation, cleaning, care and maintenance in accordance with standard practice and with the information contained above and in the user manual. This guarantee does not cover defects and damage caused by or resulting from:

- Normal wear and tear, including accessory wear
- Overload, misuse or neglect
- Repairs attempted by anyone other than an authorised agent
- Cosmetic damage
- Damage caused by foreign objects, substances or accidents
- Accidental damage or modification
- Failure to follow manufacturer's guidelines
- Loss of use of the goods

This guarantee is limited to parts recognised as defective. It does not, in any case, cover ancillary costs (movement, labour) and direct and indirect damage.

If the **Erbauer** power tool is defective during the guarantee period, then we reserve the right, at our discretion, to replace the item with a product of equivalent quality and functionality or to provide a refund.

This guarantee only applies to the country of purchase or delivery and is not transferrable to any other countries. This guarantee is non-transferrable to any other person or product. Relevant local law will apply to this guarantee.

Guarantee related queries should be addressed to a store affiliated with the distributor you purchased the **Erbauer** power tool from.

This guarantee is in addition to and does not affect your statutory rights relating to faulty goods as a consumer.

EN



DECLARATION OF CONFORMITY



EU Declaration of Conformity

We
Kingfisher International Products Limited
3 Sheldon Square
London W2 6PX
United Kingdom

Declare that the product:
Erbauer 12V charger EC12-Li
Serial number 00001-99999

Complies with the essential health and safety requirements of the following directives:

2014/35/EU Low Voltage Directive
References to the following harmonized standard were made:
EN 60335-1:2012+A11:2014+A13:2017
EN 60335-2-29: 2004+A2:2010
EN 62233:2008

2014/30/EU Electromagnetic Compatibility directive
References to the following harmonized standard were made:
EN55014-1: 2017
EN55014-2: 2015
EN61000-3-2: 2014
EN61000-3-3: 2013

(EU) 2015/863 amending 2011/65/EU Restrictions of the Use of Certain Hazardous Substances in
Electrical and Electronic Equipment

Authorised signatory and technical file holder:

Kingfisher International Products Limited
3 Sheldon Square
London W2 6PX
United Kingdom

on:18/06/2018

Lisa Davis
Group Quality Director

Manufacturer • Fabricant • Producent • Hersteller • Producator • Fabricante:

Kingfisher International Products Limited
3 Sheldon Square London W2 6PX
United Kingdom
www.kingfisher.com/products

EN DISTRIBUTOR:

B&Q plc,
Chandlers Ford, Hants, SO53 3LE
United Kingdom
www.diy.com

Screwfix Direct Limited,
Trade House, Mead Avenue,
Yeovil, BA22 8RT, United Kingdom
www.screwfix.com

To view instruction manuals online,
visit www.kingfisher.com/products